



IDC PRO 255

Installation Manual



Release Date: August 05, 2016
Publication Number: 621058578INS
Revision Date: June 20, 2018
Revision: B

Visit the Cornelius web site at www.cornelius-usa.com for all your Literature needs.

The products, technical information, and instructions contained in this manual are subject to change without notice. These instructions are not intended to cover all details or variations of the equipment, nor to provide for every possible contingency in the installation, operation or maintenance of this equipment. This manual assumes that the person(s) working on the equipment have been trained and are skilled in working with electrical, plumbing, pneumatic, and mechanical equipment. It is assumed that appropriate safety precautions are taken and that all local safety and construction requirements are being met, in addition to the information contained in this manual.

This Product is warranted only as provided in Cornelius' Commercial Warranty applicable to this Product and is subject to all of the restrictions and limitations contained in the Commercial Warranty.

Cornelius will not be responsible for any repair, replacement or other service required by or loss or damage resulting from any of the following occurrences, including but not limited to, (1) other than normal and proper use and normal service conditions with respect to the Product, (2) improper voltage, (3) inadequate wiring, (4) abuse, (5) accident, (6) alteration, (7) misuse, (8) neglect, (9) unauthorized repair or the failure to utilize suitably qualified and trained persons to perform service and/or repair of the Product, (10) improper cleaning, (11) failure to follow installation, operating, cleaning or maintenance instructions, (12) use of "non-authorized" parts (i.e., parts that are not 100% compatible with the Product) which use voids the entire warranty, (13) Product parts in contact with water or the product dispensed which are adversely impacted by changes in liquid scale or chemical composition.

Contact Information:

To inquire about current revisions of this and other documentation or for assistance with any Cornelius product contact:

www.cornelius.com

800-238-3600

Trademarks and Copyrights:

This document contains proprietary information and it may not be reproduced in any way without permission from Cornelius.

This document contains the original instructions for the unit described.

CORNELIUS INC
101 Regency Drive
Glendale Heights, IL
Tel: + 1 800-238-3600

Printed in U.S.A.

Correct Disposal of this Product



RECYCLE

This marking indicates that this product should not be disposed with other household wastes throughout the EU. To prevent possible harm to the environment or human health from uncontrolled waste disposal, recycle it responsibly to promote the sustainable reuse of material resources. To return your used device, please use the return and collection systems or contact the retailer where the product was purchased. They can take this product for environmental safe recycling.

TABLE OF CONTENTS

Safety Instructions	1
Read and Follow ALL Safety Instructions	1
Safety Overview	1
Recognition	1
Different Types of Alerts	1
Safety Tips	1
Qualified Service Personnel	2
Safety Precautions	2
Shipping And Storage	2
CO ₂ (Carbon Dioxide) Warning	2
Mounting in or on a Counter	2
System Overview	4
Features	4
Specifications	4
Installation	6
Unit Location	6
Direct Counter Installation	6
Adjusting the Carbonator CO ₂ Regulator and Turning on the Water Inlet Supply Line	8
Gate Restrictor Plate Adjustment	8
Connecting Product to the Unit	9
Water & Syrup Line Connections	9
Product Line Connections	9
Unit Operation	10
Preparing for Operation	11
Service Mode	11
Initial Setup	13
Adding Syrup	13
Mapping Brands	17
Purging The Syrup Lines	19
Syrup Line Cleaning & Sanitizing	21
Adjusting the Water to Syrup Ratio (BRIX)	22
Cleaning Interior Surfaces	24
Unit Shutdown/Restart	27
Editing the Media Playlist	28
Updating Software Revisions	31
Plumbing Diagram	33
Wiring Diagram	34
Troubleshooting	36
Unit Troubleshooting	36
Carbonator Troubleshooting	37

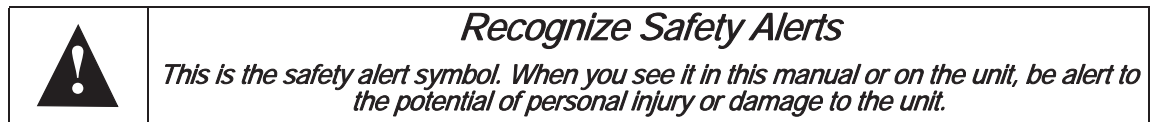
SAFETY INSTRUCTIONS

READ AND FOLLOW ALL SAFETY INSTRUCTIONS

Safety Overview

- Read and follow **ALL SAFETY INSTRUCTIONS** in this manual and any warning/caution labels on the unit (decals, labels or laminated cards).
- Read and understand ALL applicable **OSHA** (Occupational Safety and Health Administration) safety regulations and/or national and local codes before operating this unit.

Recognition



Different Types of Alerts

DANGER:

Indicates an immediate hazardous situation which, if not avoided, **WILL** result in serious injury, death or equipment damage.

WARNING:

Indicates a potentially hazardous situation which, if not avoided, **COULD** result in serious injury, death, or equipment damage.

CAUTION:

Indicates a potentially hazardous situation which, if not avoided, **MAY** result in minor or moderate injury or equipment damage.

SAFETY TIPS

- Carefully read and follow all safety messages in this manual and safety signs on the unit.
- Keep safety signs in good condition and replace missing or damaged items.
- Learn how to operate the unit and how to use the controls properly.
- **Do not** let anyone operate the unit without proper training. This appliance is **not** intended for use by very young children or infirm persons without supervision. Young children should be supervised to ensure that they do not play with the appliance.
- Keep your unit in proper working condition and do not allow unauthorized modifications to the unit.

NOTE: The dispenser is not designed for a wash-down environment and **MUST NOT** be placed in an area where a water jet could be used.

QUALIFIED SERVICE PERSONNEL

WARNING:

Only trained and certified electrical, plumbing and refrigeration technicians should service this unit. **ALL WIRING AND PLUMBING MUST CONFORM TO NATIONAL AND LOCAL CODES. FAILURE TO COMPLY COULD RESULT IN SERIOUS INJURY, DEATH OR EQUIPMENT DAMAGE.**

IF THE SUPPLY CORD IS DAMAGED, IT MUST BE REPLACED BY THE MANUFACTURER, ITS SERVICE AGENT OR SIMILARLY QUALIFIED PERSONS IN ORDER TO AVOID A HAZARD.

SAFETY PRECAUTIONS

This unit has been specifically designed to provide protection against personal injury. To ensure continued protection, observe the following:

WARNING:

Disconnect power to the unit before servicing following all lock out/tag out procedures established by the user. Verify all of the power is off to the unit before any work is performed.

Failure to disconnect the power could result in serious injury, death or equipment damage.

CAUTION:

Always be sure to keep area around the unit clean and free of clutter. **Failure to keep this area clean may result in injury or equipment damage.**

SHIPPING AND STORAGE

CAUTION:

Before shipping, storing, or relocating the unit, the unit must be sanitized and all sanitizing solution must be drained from the system. A freezing ambient environment will cause residual sanitizing solution or water remaining inside the unit to freeze resulting in damage to internal components.

CO₂ (CARBON DIOXIDE) WARNING

DANGER:

CO₂ displaces oxygen. Strict attention **MUST** be observed in the prevention of CO₂ gas leaks in the entire CO₂ and soft drink system. If a CO₂ gas leak is suspected, particularly in a small area, **IMMEDIATELY** ventilate the contaminated area before attempting to repair the leak. Personnel exposed to high concentrations of CO₂ gas experience tremors which are followed rapidly by loss of consciousness and **DEATH**.

MOUNTING IN OR ON A COUNTER

WARNING:

When installing the unit in or on a counter top, the counter must be able to support a weight in excess of **1,000 lbs.** (454 kg.) to insure adequate support for the unit. Failure to comply could result in serious injury, death or damage to the equipment.

NOTE: Many units incorporate the use of additional equipment such as ice makers. When any addition equipment is used you must check with the equipment manufacturer to determine the additional weight the counter will need to support to ensure a safe installation.



NOISE LEVEL

This unit emits acoustical noise with an A-weighted sound pressure level no greater than 75dB, as measured in accordance with ED 60335-2-75.

SYSTEM OVERVIEW

The IDC PRO 255 unit solves your ice and beverage service needs in a sanitary, space saving, economical way. It is designed to be manually filled with ice from any remote ice making source. The unit distributes cubes (up to 1-1/4 inch in size), Cubelet and compressed (not flaked) ice. Also, the unit includes beverage valves, a cold plate, an internal carbonator tank and an external pump for the carbonator.

CAUTION:

The unit cannot be used with crushed or flaked ice. Use of bagged ice which has frozen into large chunks can void warranty. The unit agitator is not designed to be an ice crusher. Use of large chunks of ice which “jam up” inside the hopper will cause failure of the agitator motor and damage to the hopper. If bagged ice is used, it must be carefully and completely broken into small, cube-sized pieces and left to “temper” or warm up for a minimum of 20 minutes in room temperature before loading into the unit hopper.

FEATURES

- Brand density - 10 brands on each side, 7 chilled, 3 ambient and up to 8 flavor shots (4 per side) for over 320 drink combinations.
- Large HD promotional display
- 255 lb. capacity ice cube hopper
- Internal cold carbonation with remote pump
- Total carb/mid-carb flexibility on each brand
- Dispenses cubed or chewable soft ice
- UI Touch screen.

SPECIFICATIONS

Table 1.

Model	IDC Pro 255
Maximum Number of Valves available	36 Total; 20 brands, 8 flavors, 4 Pain & 4 Carb
Built-in Cold Plate	Yes
Voltage	120 V 60 Hz, single phase; 8.5A. of total unit draw
	220 -240V 50 - 60Hz, single phase; 5.5A of total unit draw
Height	39-3/16 in. (.955 m) to top of Adapter lid
Depth	32-3/8 in. (0.823 m)
Width	30 in. (0.762 m)
Screen Dimensions	32 in. Diagonally
CO ₂ Operating Pressure	More than 80 psig (5.52 bar) feeding carbonator pump (75 psig (5.17 bar) fixed regulator on pump deck)
Water Pressure	50-60 psi (345-414 Kpa) at pump
Water Volume	Minimum flow rate, 125 gal/hr. (0.473 cubic meters/hr.)
Shipping Weight	545 lb. (247.2 kg)
Counter Weight	440 lb. (199.6 kg)
Ice Storage Weight	255 lbs. (115.7 kg)
Cup Clearance	9-3/4 in. (24.77 cm)
Ambient Operating Temperature	65 to 95° F (18.3 to 35° C)

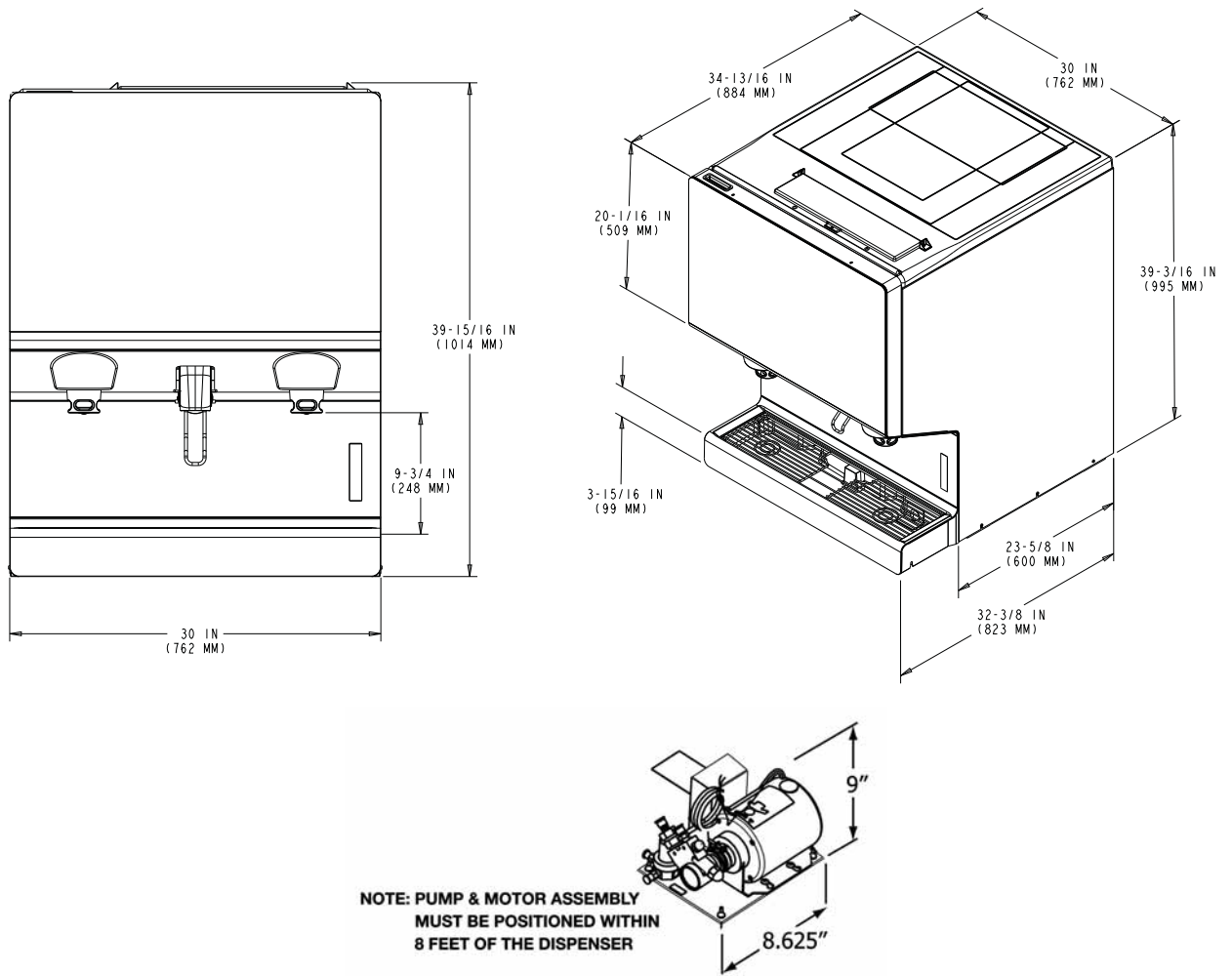


Figure 1.

INSTALLATION



WARNING:

Only trained and certified electrical, plumbing and refrigeration technicians should service this unit.

ALL WIRING AND PLUMBING MUST CONFORM TO NATIONAL AND LOCAL CODES. FAILURE TO COMPLY COULD RESULT IN SERIOUS INJURY, DEATH OR EQUIPMENT DAMAGE.



WARNING:

This equipment must be installed to comply with the International Plumbing Code of the International Code Council and the Food Code Manual 01 the Food and Drug Administration (FDA). For models installed outside the U.S.A., you must comply with the applicable Plumbing/Sanitation Code for your area.

Failure to comply could result in serious injury, death or damage to the equipment.

UNIT LOCATION

The unit must be sealed to the counter or placed on the included 4" legs (drip tray style unit only). The template drawing indicates where openings can be cut in the counter. Locate the desired position for the unit, then mark the outline dimensions on the counter using the template drawing, shown in Figure 2.. Cut the necessary openings in the counter.

DIRECT COUNTER INSTALLATION

To install the unit on a counter, perform the procedure in Table 2.

Table 2.

Step	Action
1	Locate the unit indoors on a level counter top.
2	When the unit is mounted directly on the counter top, the beverage tubes, drain tube and power cord are routed through the large opening in the bottom of the unit. See the mounting template shown in Figure 2. for locating the required clearance openings in the counter. NOTE: Recommended counter opening size 9X12 for utilities and beverage tubing. Opening can be located anywhere within the shaded area.
3	Apply a continuous bead of NSF International (NSF) silastic sealant (Dow 732 or equal) approximately 1/4-inch inside of the unit outline dimensions and around all openings. Then, position the unit on the counter within the outline dimensions. All excess sealant must be wiped away immediately.
4	Install the drain tube on to the drip tray, as shown in Figure 3..
5	Route the drain tube to an open drain with the end of the tube above the "flood" level of the drain. Use the tubing, fittings, clamps, and insulation provided with the unit to assemble the drain. The completed drain line must pitch continuously downward and contain no "traps" or improper drainage results.
6	Locate the carbonator pump assembly and connect the power cord from the dispenser to the pump. The cord is connected to the unit's electrical box and has an electrical connector on the end that plugs into a receptacle in the junction box at the carbonator pump assembly. Connect inlet water to the pump and the pump outlet to the unit using 3/8-inch food-grade tubing. Disable the pump from operating by switching the switch in the carbonator pump assembly junction box to the OFF position.
7	Connect the beverage system product tubes as indicated in the Plumbing Diagram, Figure 9.. NOTE: See the Plumbing Diagram (Figure 9.) or the decal on the lower front of the unit for the location of syrup and water connections.
8	Clean the hopper interior (see "Cleaning Interior Surfaces" section on page 24).
9	Connect the unit power cord to a 120 volt, 60 cycle, 3-wire grounded receptacle. For 220-240 Volt units, a 3-wire power cord is provided. An appropriate power cord for the particular country may need to be provided by the installer.

NOTE: Cornelius Inc. recommends that a water shutoff valve and water filter be installed in the plain water inlet supply line. A Cornelius Water Filter (P/N 313860000) and Quick Disconnect Set (P/N 313867000) are recommended.



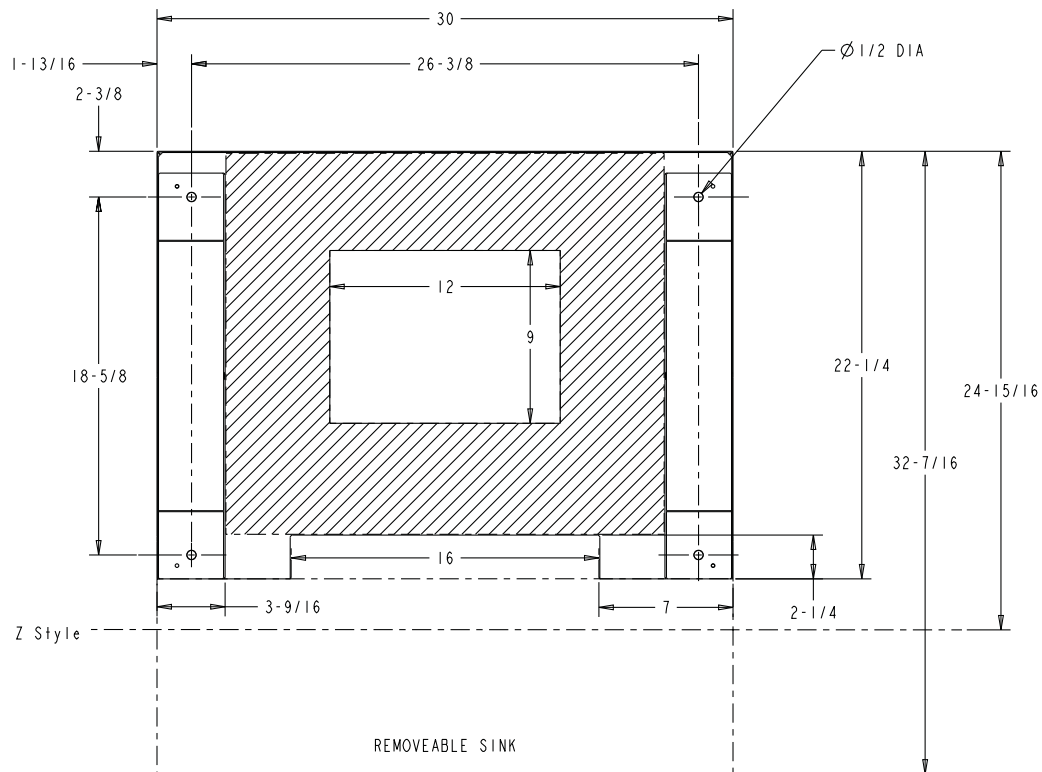
CAUTION:

Check the minimum flow rate and the maximum pressure of the plain water inlet supply line. **MINIMUM FLOW RATE MUST BE AT LEAST 125-GALLONS PER HOUR.** If flow rate is less than 125-gallons per hour, starving of the carbonator water pump can occur. Starving causes the carbonator water pump to overheat, causing the safety thermostat on the pump outlet to stop the water pump motor.



CAUTION:

INCOMING PLAIN WATER INLET SUPPLY LINE WATER TO PUMP PRESSURE MUST REMAIN A MINIMUM OF 10 psi BELOW THE CARBONATED CO₂ OPERATING PRESSURE. (Example: Carbonator CO₂ operating pressure is 75 psi and the maximum water pressure can be no more than 65 psi, etc.). Water over pressure (higher than CO₂ operating pressure) can cause carbonator flooding, malfunction, and leakage through the carbonator relief valve. If water is exceeding maximum pressure specifications, a Water Pressure Regulator Kit must be installed in the plain water inlet supply line. If a fitting connector is not available, tap into the plain water supply line with a 3/8 flare saddle valve.



RECOMMENDED COUNTER OPENING SIZE
9X12 FOR UTILITIES AND BEVERAGE
TUBING. OPENING CAN BE LOCATED
ANYWHERE WITHIN SHADED AREA.

Figure 2.

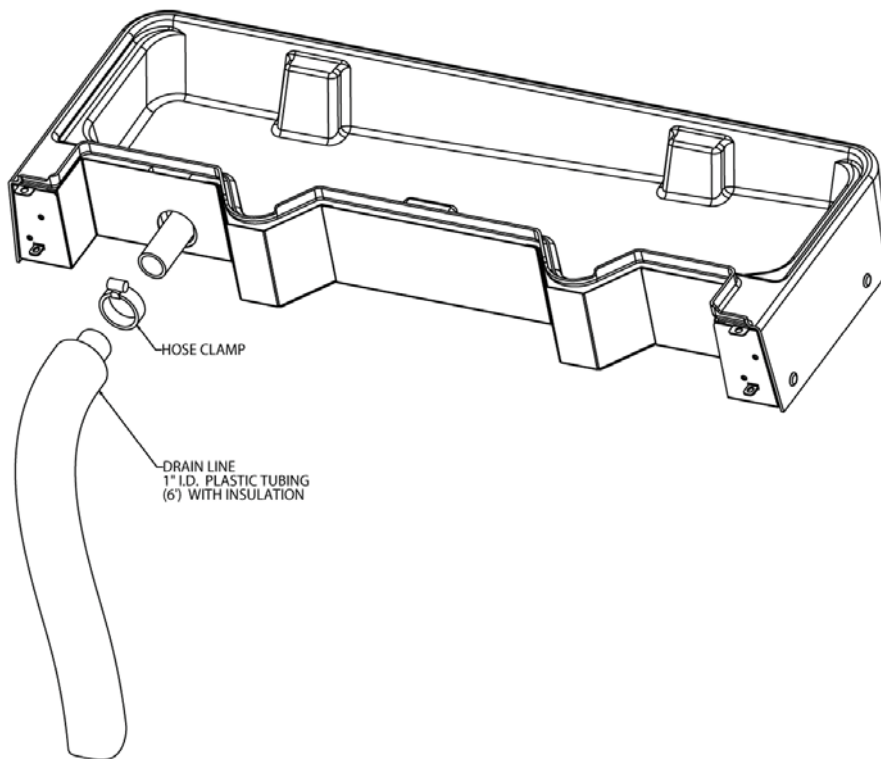


Figure 3.

ADJUSTING THE CARBONATOR CO₂ REGULATOR AND TURNING ON THE WATER INLET SUPPLY LINE

⚠ CAUTION:

Before connecting the CO₂ regulator assembly to a CO₂ cylinder, turn the regulator adjusting screw to the left (counterclockwise) until all tension is relieved from the adjusting screw spring.

1. Open (counterclockwise) the CO₂ bulk cylinder valve slightly to allow the lines to slowly fill with gas, then open the valve fully to back-seat it. (Back-seating the valve on the CO₂ bulk tank prevents leakage around the valve shaft).
2. The source CO₂ regulator must be adjusted to a minimum setting of 80 psi.

⚠ CAUTION:

Never operate the carbonator pump with the water inlet supply line shutoff valve closed. "Dry running" the water pump will burn out the pump. A pump damaged in this manner is not covered by the warranty.

3. Open the water inlet supply line shutoff valve.
4. Exercise one of the dispensing valves to exhaust trapped air inside the carbonator tank.

GATE RESTRICTOR PLATE ADJUSTMENT

The rate at which ice is dispensed is adjusted by adjusting the opening of the gate Restrictor plate as illustrated in Figure 4.

To adjust the gate Restrictor plate, loosen the four (4) nuts that hold the ice chute assembly to the hopper. The Restrictor plate can now be moved up or down. When the Restrictor plate is fully up, the ice gate opening is 2-1/2" in height, and the maximum rate of ice dispense is available (approximately 3 oz/sec). Re-tighten the four (4) nuts to set the desired Restrictor plate opening. **DO NOT EXCEED 35 IN-LB** of torque.

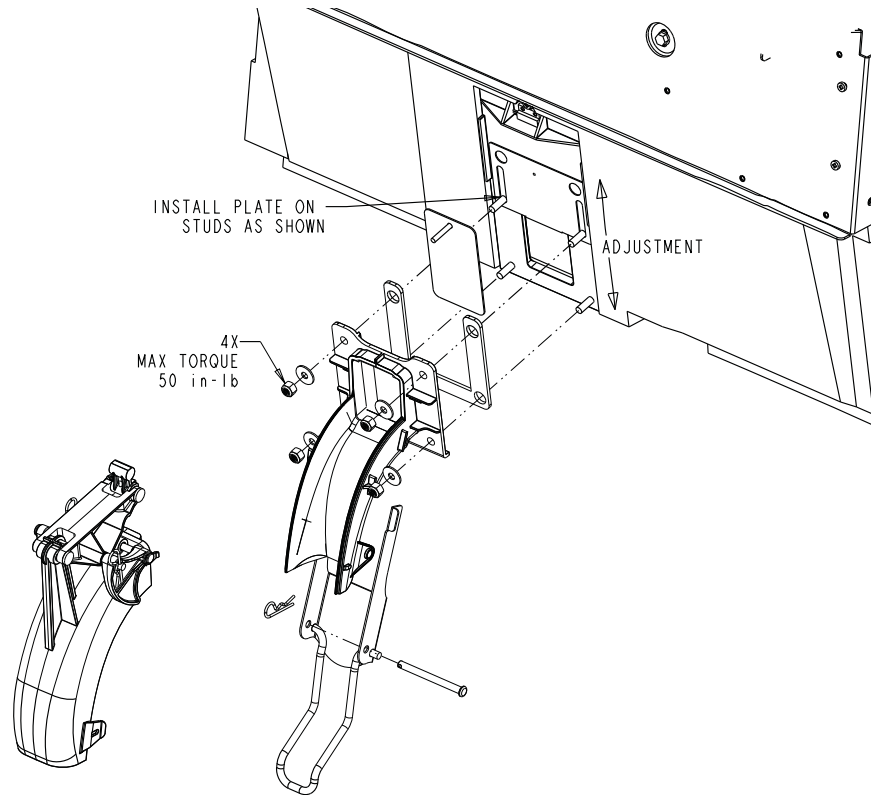


Figure 4.

CONNECTING PRODUCT TO THE UNIT

Refer to the “Plumbing Diagram” section on page 33 for details of the hook-up.

Any unused lines must remain capped.

NOTE: All inlet connections are clearly marked with a label adjacent to the inlet connections.
Always check for leaks on all connections.

WATER & SYRUP LINE CONNECTIONS

The standard unit supports the following:

- 1-water line from carbonator pump
- 1-water line for non-carbonated drinks
- 20-Syrup lines
- 8-Flavor Shots

Product Line Connections

To connect the syrup, water and flavor shot lines from the backroom package to the unit, perform the procedure in Table 3.

NOTE: If lines are to be cut, mark the line numbers above the cut with a marker. If syrup lines are mixed up they can be mapped later in the control. Make sure that syrup lines and flavor lines are **NOT** mixed.

Table 3.

Step	Action
1	Locate the water, syrup and flavor lines under the counter. The cold plate inlets are marked S1- S14 included lines labeled, A1-A6 for ambient (non chilled) syrup and F1 - F8 for flavor lines, CW for Carbonated Water, PW for plain water
2	Connect syrup lines 1-14 from the unit to the appropriate lines from the backroom package.
3	Connect the carbonated lines CW from the unit to the carbonator pump. Connect carbonator pump to backroom water supply.
4	Connect the plain water lines PW from the unit to the appropriate lines from the backroom package.
5	Adjust the CO ₂ regulator for syrup BIB pumps as indicated in Table 4.

Table 4.

Regulator	Pressure Settings
Basic Pressure Syrup Valves	75 PSI (5.17 bar)
Basic Pressure Flavor Shot Valves	45 PSI (3.1 bar)

UNIT OPERATION

WARNING:

This unit must be grounded to avoid possible electrical shock to the operator. The unit power cord is equipped with a three pronged plug. If a three pronged (grounded) outlet is not available use an appropriate method to ground the unit.

Failure to comply could result in serious injury, death or damage to the equipment.

To initially start up the unit for operation, perform the procedure in Table 5.

Table 5.


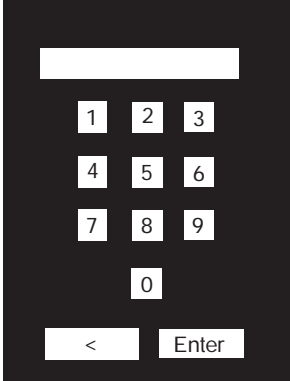
Step	Action
1	Connect electrical power to the unit.
2	Locate the switch on the junction box of the carbonator pump and turn it ON. The water pump will start and fill the carbonator tank with carbonated water. The water pump stops when the carbonator tank is full.
3	Check for water and CO ₂ leaks, and tighten any loose connections.
4	Dispense Carbonated water drinks until the carbonator pump cycles on. The refill time for the carbonator should be about 5-7 seconds.
5	If the carbonator pump appears to be short-cycling (meaning a refill time of 1-2 seconds) refer to the "Troubleshooting" section on page 36.

PREPARING FOR OPERATION

SERVICE MODE

The Service mode is used to perform all of the maintenance and troubleshooting for the unit. There are three menu levels available depending on the classification of the operator. Figure 5. shows the service mode screen for operators, Figure 6. shows the service mode screen for supervisors and Figure 7. shows the service mode screen for service technicians. To enter the service mode, perform the procedure in Table 6.

Table 6.

Step	Action	
1	<p>Display the keypad screen by tapping each corner of the video screen starting in the upper right corner and continuing to tap each corner in a counterclockwise direction, in the form of a "C".</p> <p>NOTE: As each corner is touched, a small confirmation rectangle momentarily appears to confirm the touch.</p>	
2	<p>Input the proper password for your access level (operator, manager or technician) and press Enter. The Service UI screen is displayed, as shown in Figure 5., Figure 6. or Figure 7., depending on your access level.</p> <p>NOTE: Each access level has a different password. Units are shipped with following preset passwords: 1111 (Operator level) 2222 (Manager level) 3333 technician level)</p> <p>Unless customer specific passwords are configured on a custom basis.</p>	

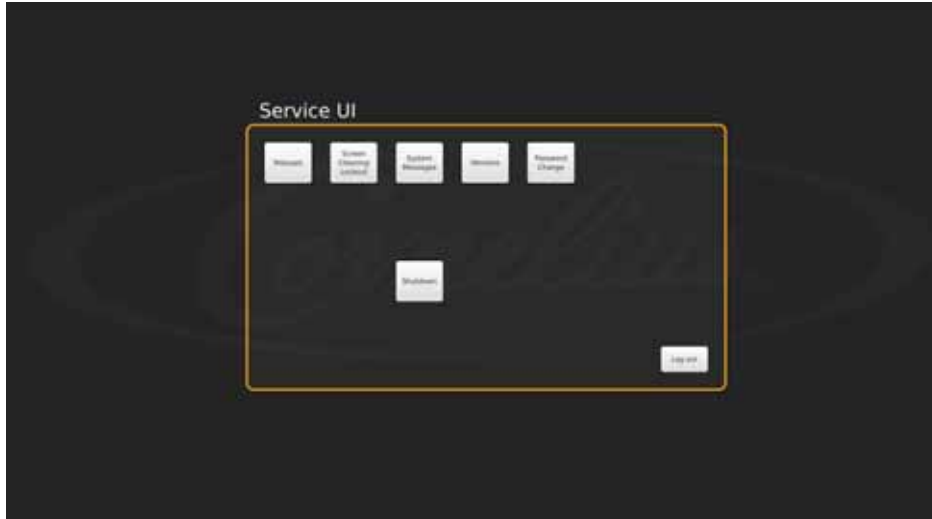


Figure 5.

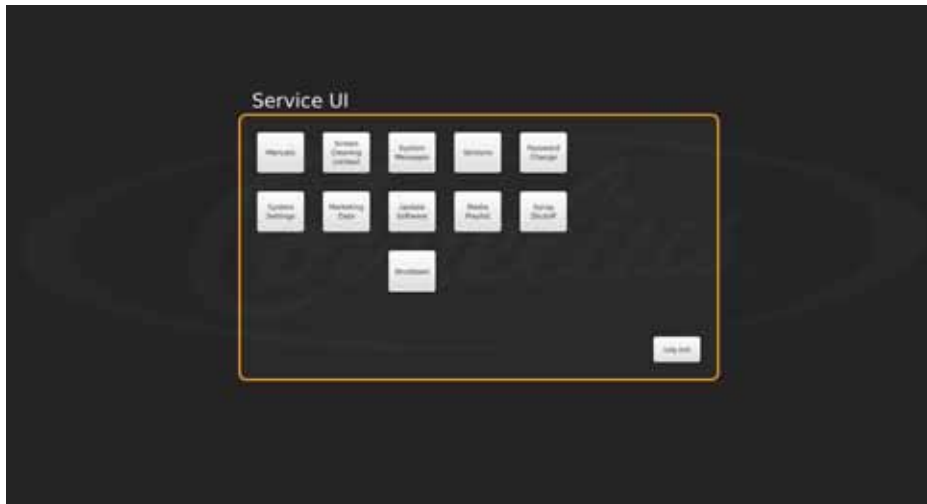


Figure 6.



Figure 7.

INITIAL SETUP

Before operating the unit, perform the initial setup described in the following sections.

Adding Syrup

First, load the images on to the machine:

Table 7.



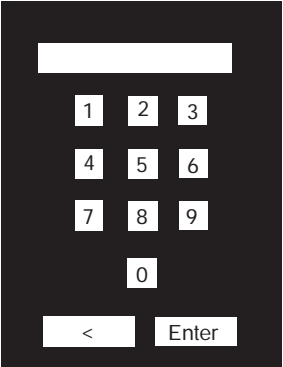
Step	Action	
1	Remove one of the USB cables from the back of the screen	
2	Install a USB drive which has the appropriate Brand or flavor images	
3	Enter Service mode using Access Pin "3333". If not changed by customer settings.	

Table 7.

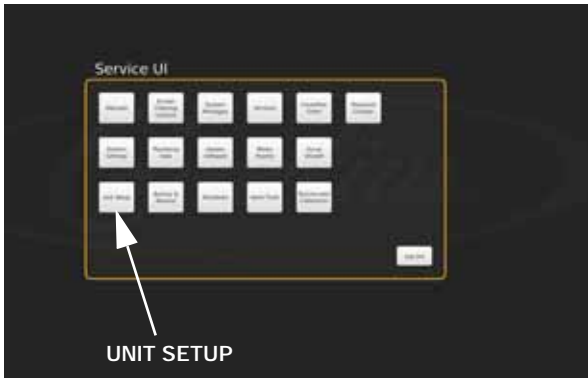
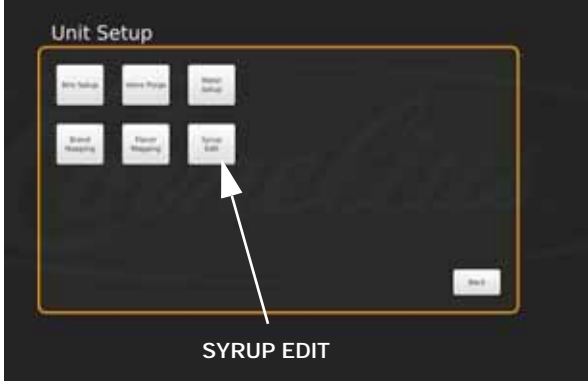


Step	Action	
4	Select "Unit Setup"	
5	Select "Syrup Edit"	
6	Select "Add/Delete Image" at the lower left.	
7	Navigate the USB drive on the LH side to find the images needed.	

Table 7.

Step	Action	
8	Select the file names needed and press the right-facing arrow in the center of the screen	
9	Press the "Back" button to return to the main "Syrup Edit" screen	
10	Remove the USB drive and replace the USB cable from the back of the screen.	

Next, setup The Brand Or Flavor:

Table 8.

Step	Action	
1	In the "Syrup Edit" screen, select the "New" button, the page icon at the bottom with "+" symbol.	
2	Now, the details for this syrup are editable on the right side of the screen	

Table 8.

Step	Action	
3	Select Name and enter the appropriate name of the syrup	
4	Select Syrup Type to select Brand or Flavor.	
5	Select Water Type to select Carbonated, Plain Water, or Mid-Carbonation (Flavors default to No Water)	
6	Select Ratio and enter the mix ratio for the specific syrup. (follow syrup manufactures specifications)	

Table 8.

Step	Action	
7	Lastly, press below image on the "+" sign and all of the loaded images will appear, find the new image that was loaded for this brand and select it.	
8	Press "Save" on the Syrup edit data screen. Press "Save" on the syrup edit screen below.	
9	Repeat for any additional flavors or brands needed.	
10	Exit the service UI	

Mapping Brands

To map the valves to the available brands, perform the procedure in Table 9.

Table 9.

Step	Action	
1	Display the keypad screen by tapping each corner of the video screen starting in the upper right corner and continuing to tap each corner in a counterclockwise direction, in the form of a "C". NOTE: As each corner is touched, a small confirmation rectangle momentarily appears to confirm the touch.	

Table 9.

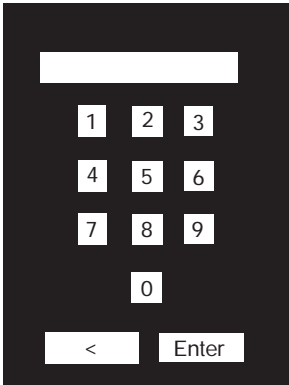
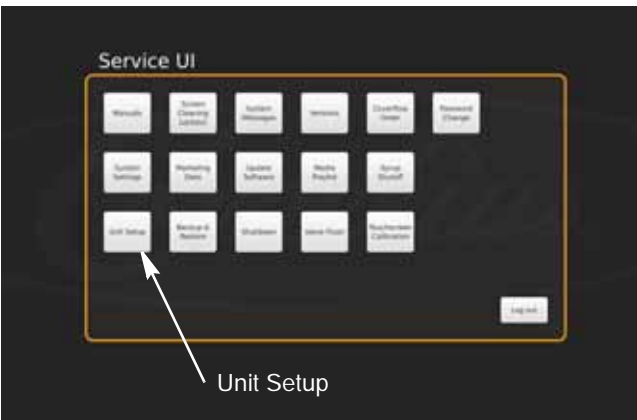
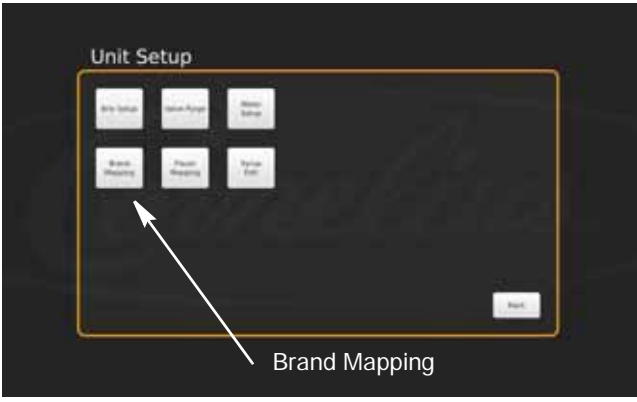

Step	Action	
2	Input the password 3333 for your access level (technician) and press Enter.	
3	The Service UI screen is displayed.	
4	Press the Unit Setup button as shown above to display the Unit Setup screen.	
5	Press the Brand Mapping button as shown above to open the Brand Mapping screen.	
6	Press the Brand or Flavor icon that is to be remapped.	

Table 9.

Step	Action	
7	The Brand Selection screen opens and you can select the brand to be mapped to the valve location.	
8	Repeat Steps 4 & 5 for each location desired.	
9	When all the flavors on the LH are mapped, press the right button and repeat steps 4 & 5 for the RH side. If the setup will be identical on the LH and RH side, press the copy to other side button and confirm when prompted.	
10	When all the flavors are mapped as desired, press the Save button to save the settings.	

Purging The Syrup Lines

The purge process is performed as part of the “Syrup Line Cleaning & Sanitizing” section on page 21. It is also used to ensure no air is in the lines before Brixing. If a BIB container is replaced, the syrup lines need to be purged and sanitized. To purge the lines, perform the procedure in Table 10.

Table 10.

Step	Action	
1	Ensure that the water and CO ₂ are turned on. (initial setup only)	
2	Display the keypad screen by tapping each corner of the video screen starting in the upper right corner and continuing to tap each corner in a counterclockwise direction, in the form of a “C”. NOTE: As each corner is touched, a small confirmation rectangle momentarily appears to confirm the touch.	

Table 10.

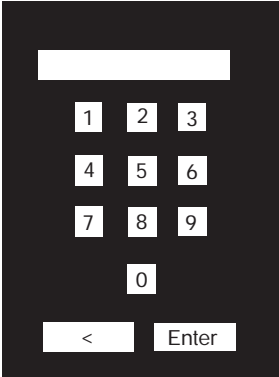
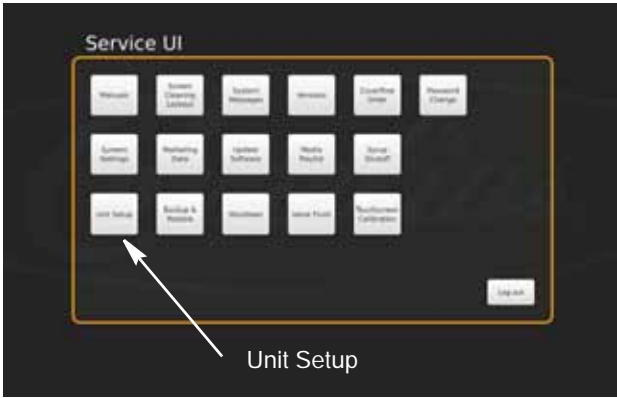
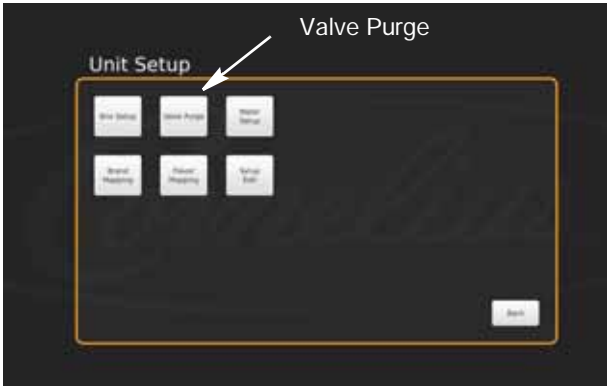

Step	Action	
3	Input the proper password for your access level (technician) and press Enter.	
4	The Service UI screen is displayed.	
5	Press the Unit Setup button.	
6	The Unit Setup screen is displayed. Press the Valve Purge button.	
7	The Valve Purge screen is displayed. Select up to 4 syrup and 2 water at a time, per side, to purge. Valves will stay activated for 12 minutes unless deactivated.	

Table 10.

Step	Action
8	When the syrup flows and lines are purged, press the same valve again to turn off, or simply select the next valve needed and the first valve selected will stop pouring.
9	Repeat Step 7 until all lines are purged.
10	When all lines are purged, press the Back button to display the Service User Interface screen and select the Log Out button.

Syrup Line Cleaning & Sanitizing



CAUTION:

Only trained and qualified persons should perform these cleaning and sanitizing procedures.

To sanitize the tubing and BIB connectors, perform the procedure in Table 11.

NOTE: No more than 7 chilled carbonated brands can be mapped per side. Specify the names of chilled vs ambient lines.

Table 11.

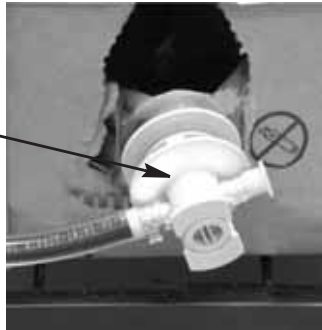


Step	Action
1	Remove all the quick disconnects from all the BIB containers. <div style="text-align: right; margin-right: 50px;">  </div>
2	Fill a suitable bucket with a soap solution.
3	Submerge all disconnects in the soap solution and then clean them using a nylon bristle brush. (Do not use a wire brush.) Rinse with clean, potable water. <div style="text-align: right; margin-right: 50px;">  </div>
4	Using a plastic pail, prepare approximately 5 gallons (18.93 l) of sanitizing solution.
5	Sanitizing fittings must be attached to each BIB disconnect. If the fittings are not available, the fittings from empty BIB bags can be cut from the bags and used. These fittings open the disconnects so the sanitizing solution can be drawn through the disconnect.

Table 11.

Step	Action	
6	<p>Place all the BIB disconnects with the sanitizing fittings in place into the pail of sanitizing solution. Use the "Purging The Syrup Lines" section on page 19 to purge the lines. Allow the sanitizer to remain in the lines for 15 minutes.</p> <p>NOTE: Recommended sanitizing solution: "Dissolve 1 packet [1 oz. (29.5 ml)] of KAY-5 into 2.5 gallons (9.5 L) of warm 80-100° F (26.7-37.8° C) potable water to ensure 100 ppm of chlorine."</p>	
7	<p>While the lines are soaking, remove the nozzles and syrup diffusers and clean them in a mild soap solution, rinse them with clean water.</p>	
8	<p>Use a spray bottle filled with sanitizing solution to spray the nozzles and diffusers and allow them to air dry.</p>	
9	<p>Reassemble the nozzles and syrup diffusers and replace them on the valves.</p>	
10	<p>Remove the sanitizing fittings from the BIB disconnects and connect the disconnects to the appropriate BIB container.</p>	
11	<p>Use the "Purging The Syrup Lines" section on page 19 to purge the lines. Continue until all the sanitizer has been flushed from the system and only syrup is flowing.</p>	

Adjusting the Water to Syrup Ratio (BRIX)

NOTE: During the Brixssing process, agitate the ice in the bin occasionally to ensure that the cold plate is at the proper operating temperature.

Water and syrup MUST be cold before checking BRIX.

The unit must be BRIXed initially before the unit is put into operation. To BRIX the unit, perform the procedure in Table 12.

Table 12.


Step		Action
1	<p>Display the keypad screen by tapping each corner of the video screen starting in the upper right corner and continuing to tap each corner in a counterclockwise direction, in the form of a "C".</p> <p>NOTE: As each corner is touched, a small confirmation rectangle momentarily appears to confirm the touch.</p>	

Table 12.

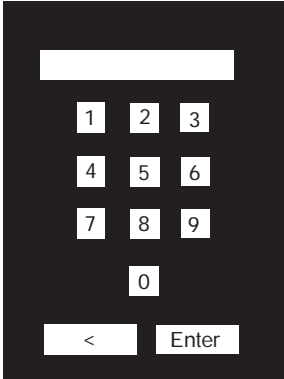
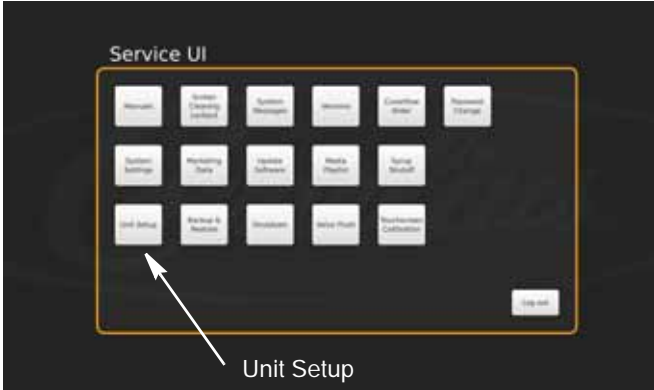


Step		Action
2	Input the proper password for your access level (technician) and press Enter.	
3	Press the Unit Setup button.	
4	Select the Brix setup screen.	
5	All instructions and volumes below are based on the pour rate of 3oz/sec. NOTE: When selecting a valve, it will activate for a pre-programmed 4 second dispense time.	
6	Place a Ratio cup under the valve.	
7	Select the CW1 button and press Pour to dispense 7.0 oz (210 ml.).	
8	If the flow rate is not correct, adjust the proper valve to the desired flow. Refer to Figure 8. for valve locations.	

Table 12.

Step	Action
9	Turn the flow adjustment valve a 1/4 of a turn at a time and recheck the flow. To increase the flow, turn the knob clockwise. To decrease, turn counter- clockwise.
10	Test the valve and adjust until a consistent ratio is delivered two consecutive times.
11	Select CW2 and press Pour to dispense 3.0 oz (90 ml.)
12	Perform Steps 8 through 10 for the CW2 valve.
13	Select PW1 and press Pour to dispense 7.0 oz (210 ml.).
14	Perform Steps 8 through 10 for the PW1 valve.
15	Select PW2 and press Pour to dispense 3.0 oz (90 ml.)
16	Perform Steps 8 through 10 for the PW2 valve.
17	Select CW3 and Pour to dispense 7.0 oz (210ml.).
18	Perform Steps 8 through 10 for the CW3 valve.
19	Select CW4 and press Pour to dispense 3.0 oz (90 ml.)
20	Perform Steps 8 through 10 for the CW4 valve.
21	Select PW3 and press Pour to dispense 7.0 oz (210 ml.).
22	Perform Steps 8 through 10 for the PW3 valve.
23	Select PW4 and press Pour to dispense 3.0 oz (90 ml.)
24	Perform Steps 8 through 10 for the PW4 valve.
25	Place a graduated cylinder under the valve.
26	Select S1 and press Pour to dispense follow manufacturer's specs for proper ratio.
27	If the rate is not correct, perform Steps 8 through 10 for the S1 valve.
28	Repeat Steps 26 and 27 for S2 through S7 and A1 through A3.
29	Repeat Steps 26 through 27 for S8 through S14 and A4 through A6.
30	When the flow rate process is complete, select the Back button to return to the Unit Setup screen.
31	Press the Back button on the Unit Setup screen to return to the Service UI screen.
32	Press the Log Out button to return to normal operation.

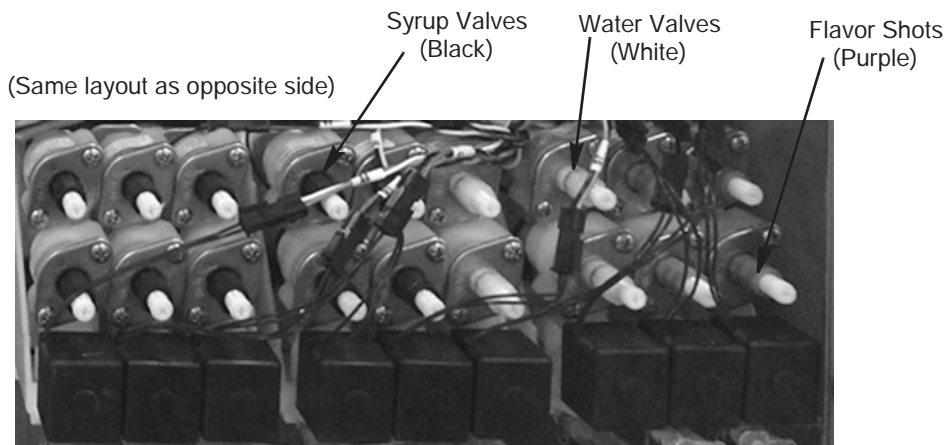


Figure 8.

Cleaning Interior Surfaces

As part of the initial cleaning procedures, clean and sanitize the ice hopper by performing the procedure in Table 13.

CAUTION:

When pouring liquid into the hopper, do not exceed the rate of 1/2 gallon per minute. Pouring liquid into the hopper faster than the recommended rate could result in an overflow situation which may result in personal injury or damage to the equipment.

Table 13.





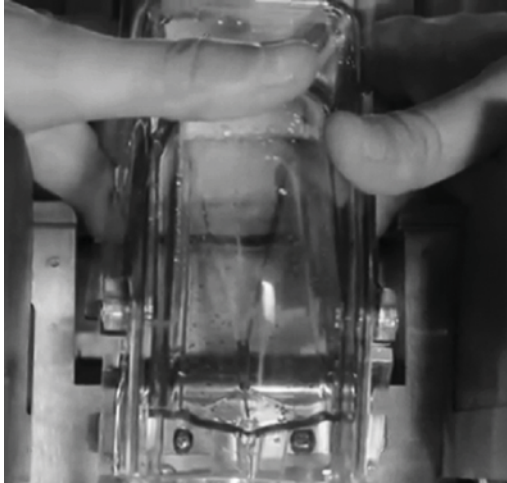


Step	Action	
1	Remove the agitator assembly by unscrewing the thumbscrew and lifting the agitator assembly out of the hopper.	
2	Using a nylon bristle brush or sponge, clean the interior of the hopper, top cover and agitator assembly with soap solution. Thoroughly rinse the hopper, cover and agitator surfaces with clean potable water.	
3	Reassemble agitator assembly. Take special care to ensure that the thumbscrew is tight.	
4	Using a mechanical spray bottle filled with sanitizing solution, spray the entire interior and the agitator assembly. Allow them to air dry.	

Table 13.

Step	Action	
5	Open the display panel and remove the ice chute cover from the unit.	
6	With a nylon bristle brush or sponge, clean the inside of the ice chute, gasket, and cover with soap solution and rinse thoroughly to remove all traces of detergent.	
7	Reassemble the ice chute assembly.	
8	Using a spray bottle filled with sanitizing solution, spray the inside of the ice chute. Allow it to air dry.	
9	Close the display panel.	

UNIT SHUTDOWN/RESTART

The unit can be shutdown by entering the service UI at any level and selecting the “shutdown” icon. To shut down or restart the unit, perform the procedure in Table 14.

Table 14.

Step	Action	
1	Display the service screen by tapping each corner of the video screen starting in the upper right corner and continuing to each corner in a counterclockwise direction, in the form of a “C”. As each corner is touched, a small confirmation rectangle momentarily appears to confirm the touch.	
2	Select the Shutdown button to display the Shutdown/Restart Screen, as shown.	
3	Press “Restart” to power cycle the screen or “Shut down” turn off the screen. NOTE: The rest of the unit components are still receiving power.	

EDITING THE MEDIA PLAYLIST

The unit is capable of changing the display video on a preprogrammed schedule. This allows the user to set a specific time and duration for playing a specific media for breakfast, lunch, dinner or any special media required.

To set the media playlist schedule, perform the procedure in Table 15.

Table 15.

Step	Action	
1	First, enter the Service Screen at either manager or technician level permissions.	
2	<p>Tap each corner of the video screen starting in the upper right corner and continuing to each corner in a counterclockwise direction, in the form of a "C".</p> <p>NOTE: As each corner is touched, a small confirmation rectangle momentarily appears to confirm the touch.</p>	
3	Input the proper password for your access level and press Enter. This will take you to the Service UI screen.	
4	<p>This is where you can access the videos (Media Playlist)</p> <p>To start with changing the playlist, select the "Media Playlist" button. This brings you to this screen (only the default playlist appears initially).</p>	

Table 15.


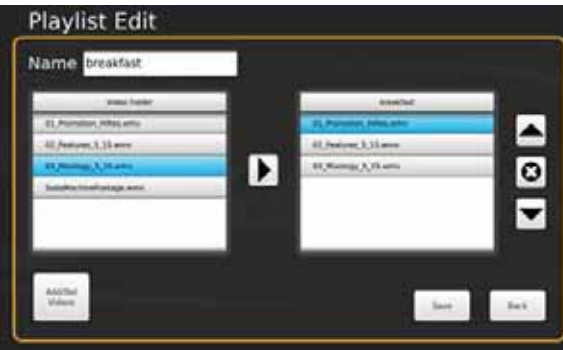


Step	Action	
5	<p>First, to manipulate the playlist and their schedule. A new playlist can be added by selecting the second button on the bottom left (with the + symbol). This will add a new playlist in addition to the default playlist. The times when it starts playing and finishes can be adjusted by dragging the play and stop icon left and right. The corresponding times appear in the bar shown. So, the "breakfast" playlist above plays from 7:30 to 9:00am. The default playlist will fill in the gaps and plays unless any other playlist is set at that time.</p> <p>Now, to modify what's actually in these playlist (or their names), select the pencil on the RH side of the playlist. The next screen will appear:</p>	
6	<p>At the top is the name, click on the white box and a keyboard will appear to allow you to change the name. Below this are two lists of videos. On the RH side is the playlist that you are editing. The videos will play, starting at the top, and repeat, throughout its specified time. To remove a video from the playlist, select it from the list and press the 'X' on the right side. To add a video that is on the machine to the playlist, select it from the list on the left and press the arrow in the center. The position of this video can be changed by using the 'up' and 'down' arrows on the right.</p> <p>Static image option: you can add JPEG and PNG file to the playlist and adjust their duration with the slider on the media playlist menu.</p> <p>To add a video from a USB drive, select the "Add/Del Videos" button in the bottom left. Next screen will pop up:</p>	

Table 15.

Step	Action	
7	All the videos or images currently on the machine are shown on the right. A USB stick that is connected to any of the (3) available ports will be displayed on the left. Click on the name of the drive and, subsequently, through any folders to find the videos to be added.	
8	These videos can be transferred to the machine by selecting them and pressing the arrow button in the center. Any videos that were added are now available to the playlist by pressing the 'Back' button. File can also be copied from the machine to USB drive by selecting the files on the RH side and pressing the left facing arrow.	
9	Important Note: Please press save on the Playlist Edit screen and again on the Media Playlist screen when making any changes.	
10	To export sales information, return to the main service UI. Insert a USB drive in an available USB slot on the back of the door. Select "Marketing Data" and again select "Export Data". The data will be exported directly to the USB.	

UPDATING SOFTWARE REVISIONS

The unit can be updated as new versions of software become available, they may be installed on the unit by performing the procedure in Table 16.

Table 16.


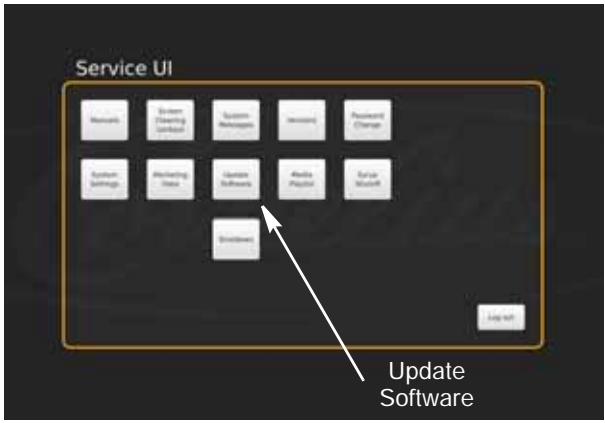


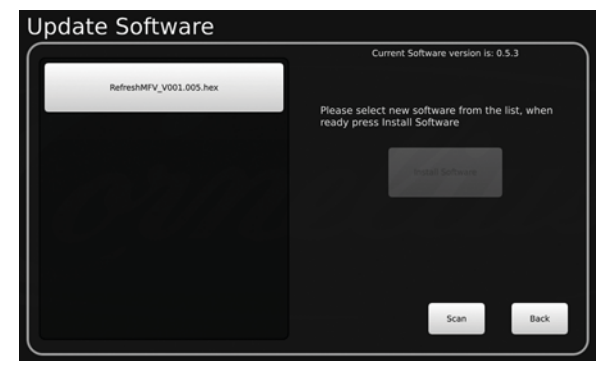
Step	Action	
1	Enter Service mode, as described in "Service Mode" section on page 11.	
2	Open the display panel.	
3	On the back of the display, unplug the USB connection to the ADA panel and plug in the USB stick with the software update loaded on it.	
4	Press the Update Software button.	
5	The Update Software screen is displayed. Press the Launch Software Updater button.	

Table 16.

Step	Action	
6	The Software Updater screen is displayed. Press the Update Software button.	
7	The second Update Software screen is displayed.	
8	Select the software version to be installed by selecting from the list on the left side of the screen. If the list on the left side of the screen is empty, press the Scan button. This reads the software updates contained on the USB stick. When the proper version is highlighted, press the Install Software button on the right side of the screen.	
9	When the update is complete, press the Back button to revert to the previous screen, then press the Restart/Refresh button to restart the Screen.	
10	Unplug the USB stick from the connector and reinstall the ADA cable.	
11	Close the display panel.	

PLUMBING DIAGRAM

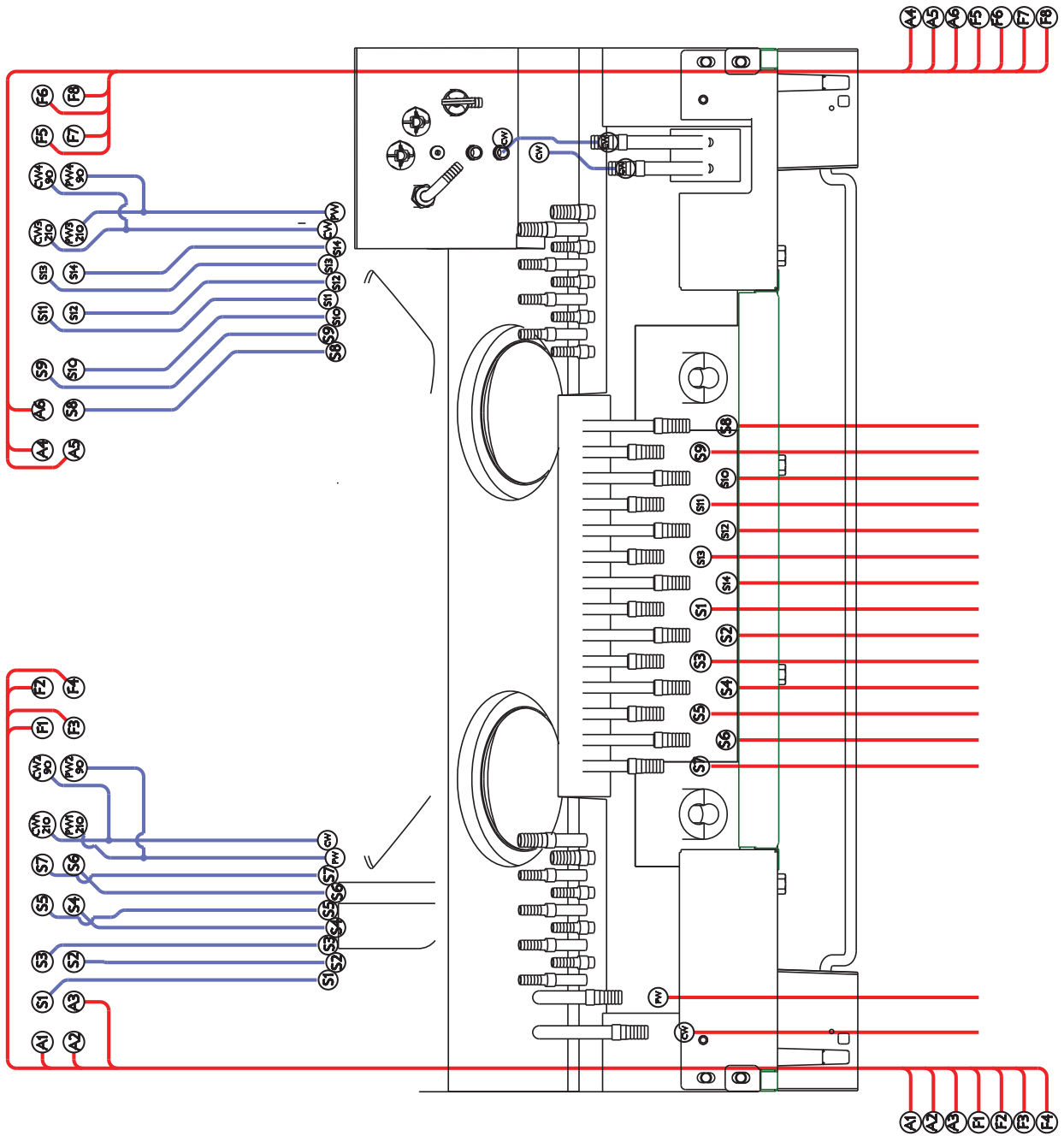


Figure 9.

- S - Syrup Line.
- F - Flavor Line.
- A - Ambient Line.

WIRING DIAGRAM

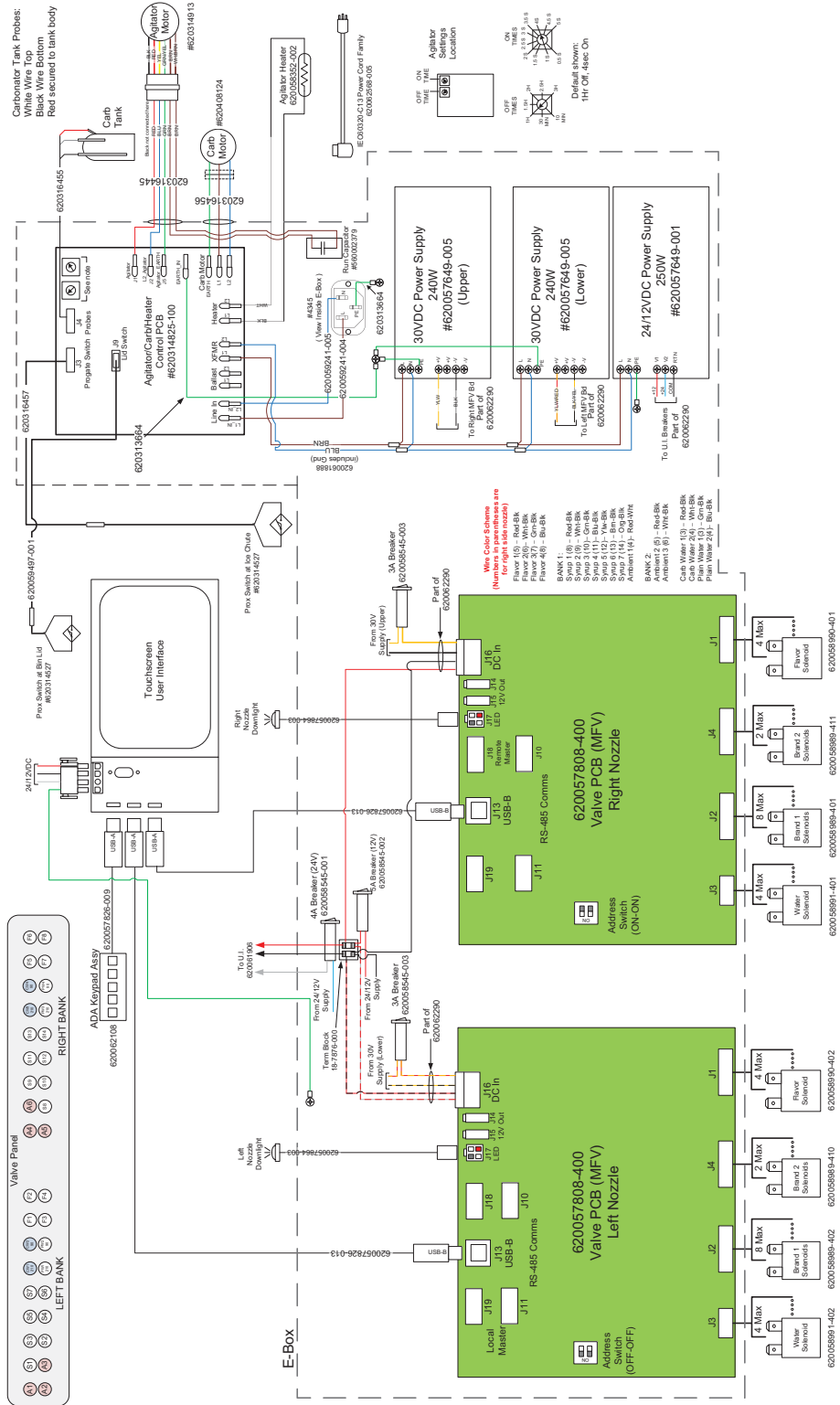


Figure 10. 115V premium unit wiring

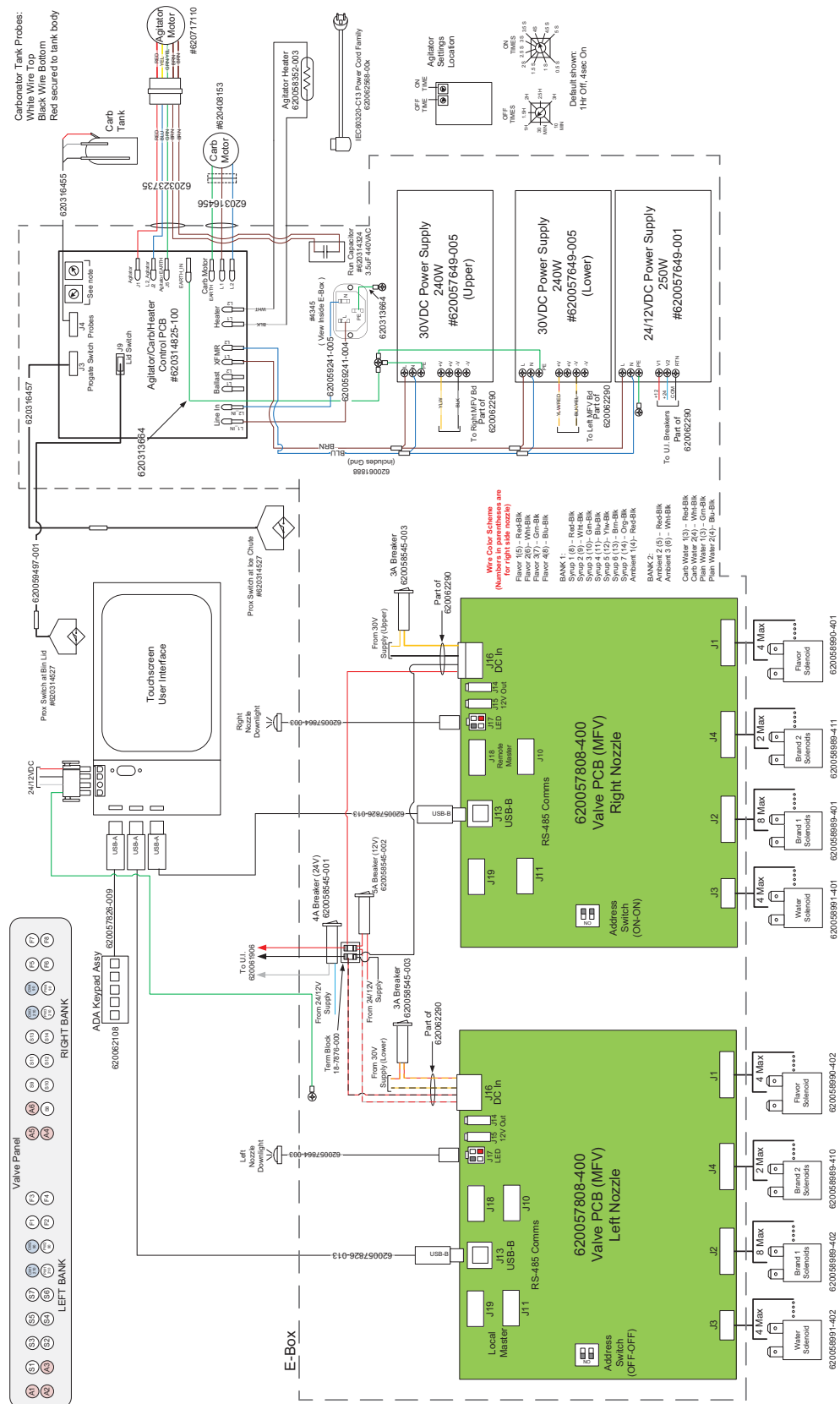


Figure 11. 230V premium unit wiring

TROUBLESHOOTING

WARNING:

Only trained and certified electrical, plumbing and refrigeration technicians should service this unit.

ALL WIRING AND PLUMBING MUST CONFORM TO NATIONAL AND LOCAL CODES. FAILURE TO COMPLY COULD RESULT IN SERIOUS INJURY, DEATH OR EQUIPMENT DAMAGE.

WARNING:

If repairs are to be made to a product system, remove quick disconnects from the applicable product tank, then relieve the system pressure before proceeding. If repairs are to be made to the CO₂ system, stop dispensing, shut off the CO₂ supply, then relieve the system pressure before proceeding. If repairs are to be made to the refrigeration system, make sure electrical power is disconnected from the unit.

Should your unit fail to operate properly, check that there is power to the unit and that the hopper contains ice. If the unit does not dispense, check the following chart under the appropriate symptoms to aid in locating the defect.

UNIT TROUBLESHOOTING

Table 17

Symptom	Cause	Remedy
Blown fuse or circuit breaker	A. Short circuit in electrical wiring B. Inoperable agitator motor (shorted motor)	A. Repair wiring B. Replace gear motor
Agitator does not turn	A. No power B. Improperly installed upper ice chute assembly (Reed switch is not being activated) C. Inoperable reed switch D. Electrical board driver circuit is defective E. Gear motor has open circuit F. Reed switch is not activated, improper assembly of upper ice chute to lower chute G. Broken wire in the 2-wire harness leading to the reed switch H. Bad connection at main control board.	A. Restore power or plug in unit B. Check the upper ice chute assembly for proper assembly and operation C. Replace reed switch D. Replace main control board E. Replace gear motor F. Check to make sure tongue of upper chute engages into the back of the lower chute, ensure upper chute engages outside the lower chute, and snap front of chute into place G. Repair or replace 2-wire harness H. Repair connection or replace 2-wire harness
Ice dispenses continuously	A. Ice gate mechanism is stuck in open position B. Stuck or bent ice lever (does not allow gate to close and open reed switch)	A. Inspect gasket for proper position. Examine gate plate to see if it slides freely behind the lower ice chute. B. Examine ice dispense lever to see if it is bent.
Slushy ice or water in hopper	A. Blocked drains in cold plate B. Poor ice quality due to water quality or ice maker problems	A. Remove access covers in cold plate cover & inspect/clean drains B. Correct water quality or repair ice maker
Beverage does not dispense	A. No 24VAC to valves B. No CO ₂ pressure	A. Restore 24 VAC to valves B. Restore CO ₂ pressure
Beverage is too sweet	A. Valve BRIX requires adjustment B. Carbonator is not operating C. No CO ₂ in carbonator D. City water pressure supply low or inconsistent	A. Adjust valve BRIX B. Repair carbonator C. Restore CO ₂ pressure in carbonator D. Booster pump must be used if dynamic water pressure drops below 40 psig.

Table 17

Symptom	Cause	Remedy
Unit will not dispense carbonated drinks. Dispenses syrup only.	A. CO ₂ pressure in carbonator tank is too high. B. Water valve will not open	A. Check CO ₂ pressure regulator setting. 75 psig recommended. Relieve pressure from carbonator tank. B. Check electrical connection to water valve. Check resistance of coil (should be 9 ohms). Check for voltage at coil when brand button is depressed.
Unit will not dispense carbonated drinks. Spurts CO ₂ and syrup only.	A. Carbonator tank is empty, because tank was emptied while power was applied to unit. 5 minute time-out of carbonator pump/motor occurred and carbonator pump is locked off. B. Note that this can occur while the water filter system is serviced or water supply is shutoff. If drinks are drawn from the unit while water pressure is shutoff, the carbonator pump starts and runs continuously, then shuts off on the 5 minute timeout.	A. Unplug the unit and reconnect the unit. Main control board will reset, ice agitation will occur, and carbonator tank will refill to normal level. B. 1) low water pressure switch deactivates carbonator pump, 2) after 5 minutes reset and retry carbonator pump. If water supply is restored, the 5 minute timeout will not occur. Repeat reset a second time, but on a third time, then lockout carbonator pump, which will generate a service call.
Carbonated drinks are flat (low on carbonation)	A. Unit is out of CO ₂ B. Carbonator tank is 100% filled because the city water pressure exceeds the carbonator tank CO ₂ pressure regulator setting.	A. Replace CO ₂ cylinder B. CO ₂ setting for the carbonator tank is 75 psig, max water pressure is 60 psig. If necessary, install a water pressure regulating valve.
Low water pressure	A. Could be caused by excessively long runs (over 40 ft.) of 3/8" water supply line. B. Low water pressure C. Plugged water filter D. Water booster bladder has burst	A. Increase line size to 1/2" B. Add water pressure booster pump C. Change water filter D. Replace water booster tank/bladder

CARBONATOR TROUBLESHOOTING

Table 18

Symptom	Cause	Remedy
Carbonator pump does not start to fill tank	A. Power cord for the carbonator pump motor is not connected	A. Carbonator pump is powered off the main control board inside the electrical box of the unit. Check that the umbilical cord is connected from the unit to the pump motor terminal box.
Power cord is connected but carbonator pump does not run	A. Carbonator pump motor is disabled B. Probes were dry, unit was powered up, water was not turned on, and carbonator did not fill C. Water service was interrupted for more than 5 minutes	A. Check the enable/disable switch on the carbonator pump terminal box and enable it, if necessary. B. This results in a 5 minute timeout. Unplugging the unit and plugging it in will reset the unit and start the carbonator pump C. Unplugging the unit and plugging it in will reset the unit and start the carbonator pump
Carbonator pump is short cycling with every drink drawn	A. Lower liquid level probe reads "dry" while upper probe reads "wet"	A. Check color of leads going to probes. Black should go to bottom probe and white to top probe. Reverse if incorrect.

Table 18

Symptom	Cause	Remedy
Carbonator tank overfills, overflows through relief valve, and pump shuts off after 5 minutes.	<ul style="list-style-type: none"> A. Poor electrical connections between carbonator tank and main control board. B. Broken wires between carbonator tank and main control board. C. Defective liquid level probes. 	<ul style="list-style-type: none"> A. Check connections at carbonator tank and at connector J4 on the main control board B. Replace wire harness. C. Replace both liquid level probes.

NOTE: Contact your local syrup or beverage equipment distributor for additional information and troubleshooting of beverage system.

Cornelius Inc.
www.cornelius-usa.com