



**Gulf Ice  
Systems**

**2024 +  
Ice Making & Beverage  
Dispensing Equipment  
Catalog**



*Providing Ice and Beverage Solutions*

*Since 1985*

7790 Sears Blvd.  
Pensacola, FL 32514  
(850) 322-4853  
Fax: (850) 477-2458

**1-800-322-4853**

**Sales • Service • Support**  
[www.gulficesystems.com](http://www.gulficesystems.com)



In business since 1985

# Full Line Ice & Beverage Equipment Distributor

Gulf Ice Systems, Inc., (GIS) has been a leading supplier of ice making and beverage dispensing equipment to the ice and beverage industry since 1985. Our customer base includes various components of the bottling network, government agencies, large C-Store chains, hospitals, hotels, full service restaurants, fast food chains, restaurant and supply dealers, juice distributors and coffee roasters, among many others.

P.O. Box 11008, Pensacola, FL 32524  
7790 Sears Blvd, Pensacola, FL 32514

(850) 474-1784 (Telephone)  
(800) 322-4853 (Toll Free)  
(850) 477-2458 (FAX)

SALES@gulficesystems.com (General E-Mail)

www.gulficesystems.com

**Sales Department**

[sales@gulficesystems.com](mailto:sales@gulficesystems.com)

**Parts Department**

[parts@gulficesystems.com](mailto:parts@gulficesystems.com)

**Shipping Department**

[trucking@gulficesystems.com](mailto:trucking@gulficesystems.com)

**Service Department**

[service@gulficesystems.com](mailto:service@gulficesystems.com)

**Warranty Department**

[warranty@gulficesystems.com](mailto:warranty@gulficesystems.com)

**AR Department**

[arpayments@gulficesystems.com](mailto:arpayments@gulficesystems.com)

**AP Department**

[ap@gulficesystems.com](mailto:ap@gulficesystems.com)

**Website / Online Store**

[admin@gulficesystems.com](mailto:admin@gulficesystems.com)

Gulf Ice Systems staffs  
over 30+ fulltime employees  
to provide support and service..



Operator  
1-800-322-4853  
Press 0

Published 2024, Copyright © Gulf Ice Systems, Inc., All Rights Reserved

Product pictures provided in this catalog are either the property of Gulf Ice Systems, Inc. or authorized for use by the manufacturer or vendor. Re-use by other entities is prohibited. The catalog design, charts, and images are produced by Gulf Ice Systems and remains the intellectual property thereof. Any reproductions of this catalog are prohibited by law.





# 2024 + Dealer Catalog

## Table of Contents

	Page(s)
Ice Machines	2-20
Ice Machine Adapter Chart (Bins)	12-15
Ice Cooled Beverage Dispensers	21
1522, 1722, 2323 Ice Cooled Stands	22
1522, 2123 Ice Chests and Ice Tainers	23-27
Ice and Beverage Combo Dispensers	26-27, 33-34
Flavor Blast Retro Fit Kits	29
Ice and Beverage Combo Stands	30
Ice and Beverage Combo Accessories	31
Ice Machine Adapter Chart (Ice-Bev)	32-34, 37-40
IDC Beverage Dispensers	35
Flavor Fusion and Flavor Overload	36
Carbonators and Accessories	41-42
Cold Plates	42
Water Filtration Systems	43-59
Juice Dispensers	60-63
Cold Beverage Visual Dispensers	64-65
Cold Coffee Dispensers	66
Frozen Beverage Dispensers	67-71
Slush-Granita Dispensers	72
Tea Dispensers	73-74
Tea Brewers	75-76
Coffee (Tea) Brewer and Accessories	76-81
Cappuccino Dispenser	78
Bar Guns	82-85
Icemaker Cleaners, Scale Remover	86
Beverage Valves	87-89
Bag-In-Box (BIB) Rack Shelves	90-92
Bag-In-Box (BIB) Rack Systems	93-97
Bag-In-Box (BIB) Air Pump Station	98
Water Boosters	98-99
Bag-In-Box (BIB) Installation Kits	100-101
Bag-In-Box (BIB) Connectors, Sanitizers	102-103
Bag-In-Box (BIB) Syrup Pump Kits	104
Bag-In-Box (BIB) Syrup Pumps	104-107
Brix Pumps	107
Bag-In-Box (BIB) Syrup Pump Fittings	81-82
Automatic Selector Valves (ASV)	108
Digital Refractometer	109
Bag-In-Box (BIB) Syrup Pump Accessories	110
Bag-In-Box (BIB) Syrup Pump Fittings	111-112
Beverage System Fittings	113-116
CO2 Regulators and Accessories	117-122
Beverage Tubing, Hose and Tools	123-125
Cup and Lid Dispensers	126-138
Visi-Slide Shelf and Pusher Glides	139-140
Camtainers	141
Camservers	142
Portable Beverage Bars	143-145
Request for Quote Form	** Back of Catalog



*Download a digital copy of our  
Ice Making & Beverage Dispensing  
Equipment Catalog*

The cover of the 2024+ Ice Making & Beverage Dispensing Equipment Catalog features a vibrant pink and orange flamingo standing next to a glass of iced tea with a lemon slice and a red straw. The background is a teal gradient. The Gulf Ice Systems logo is in the top left. The title "2024 + Ice Making & Beverage Dispensing Equipment Catalog" is in yellow text in the top right. A yellow starburst contains contact information. At the bottom, it says "Sales • Service • Support" and "www.gulficesystems.com".

**2024 +**  
Ice Making & Beverage  
Dispensing Equipment  
Catalog

*Providing Ice and Beverage Solutions*  
Since 1985

Sales • Service • Support  
[www.gulficesystems.com](http://www.gulficesystems.com)

7790 Sears Blvd.  
Pensacola, FL 32514  
(850) 322-4853  
Fax: (850) 477-2458

**1-800-322-4853**

Published 2024 Copyright ©, Gulf Ice Systems, Inc. All Rights Reserved

You can download a digital copy of our newest catalog from our website!

[www.GULFICESYSTEMS.com](http://www.GULFICESYSTEMS.com)



## Index by Vendor

	Page
--	------

### ACCUFLEX

Beverage Tubing and Hose, Tools and Accessories	125
Beverage Tubing and Hoses	123-124

### BUNN

Accessories, Coffee or Tea Brewers	77, 81
Axiom Coffee Decanter Brewer	79
Cappuccino Dispenser	78
Infusion Coffee Brewer	80
ITCB-DV Coffee or Tea Brewer	76
JDF Juice Dispensers	63
Tea Brewers, Automatic	75-76
Ultra NX Frozen Beverage System	72

### CAMBRO

Camtainers	141
Camservers	142
Portable Beverage Bars	143-145

### CORNELIUS - MARMON

1522, 2123 Ice Chests and Ice Tainers	23-27
1522, 2323 Ice Cooled Beverage Drop-In Dispensers	21
1522, 2323 Ice Cooled Beverage Drop-In Stands	22
Beverage Valves	87-89
Carbonator, VA Balance and Small Carb	41
CO2 Primary Regulators for Soda Systems	119
CO2 Secondary Regulators for Soda Systems	120
Enduro, Ice and Beverage Combo Dispensers	28
Enduro, Flavor Blast Dispensers	29
Enduro, Flavor Blast Retro Fit Kits	31
Flavor Fusion	36
Flavor Overload	36
IDC Pro Fast Gate, Ice and Bev Combo Dispensers	35
IDC Pro, Ice and Beverage Combo Dispensers	35
Ice and Beverage Combo Stands, Enduro	30
Ice and Water Dispensers, Enduro Models	17
Ice Maker Adaptor Chart for Enduro Application	32-34
Ice Maker Adaptor Chart for FF, FO, IDC Application	33, 37-38
IMD Ice Maker Dispensers, Self-Contained	19
Ice Tainer Leg Assemblies	25-26
Nitropro Mini Specialty Beverage Dispenser	66
Quest Elite 2-4 Curve Juice Dispensers	60
Quest Elite 2-4 Single Panel Juice Dispensers	61
Quest Elite 2-4 Multi-Panel Juice Dispensers	62
Remote Condenser, Nugget	8
Tea or Juice Tower, 2-Flavor	74
Viper 2-3-4 Carts	68
Viper 2-3-4 Frozen Carbonated Beverage (FCB)	67
WCC Ice Machine, Chunklet	8

	Page
--	------

### CRATHCO - GRINDMASTER

Visual Display Classic Cold Beverage Dispensers	64
Visual Display Simplicity Cold Beverage Dispensers	65

### DISPENSE-RITE

Cup and Lid Dispensers and Organizers	126-138
---------------------------------------	---------

### DISPLAY TECHNOLOGIES

Visi-Slide Shelf Glides	139
Cold Vault Add-A-Shelf	140
Visi-Fast Pusher Glides	140

### EVERPURE

ScaleKleen Deliming/Scale Remover	86
Water Filtration Heads, Manifolds	56
Water Filtration Systems, Carbonated Beverage	46-50
Water Filtration Systems, Coffee and Tea Brewers	55
Water Filtration Systems, Combo	51-54
Water Filtration Systems, Ice Machines	43
Water Filter Replacement Cartridges	58-59

### FBD

372-373-772-773-774 Frozen Carbonated Beverage	69-71
772-773-774 Carts	70

### FITTINGS INC.

Beverage System Fittings	113-114
Cold Plates	42

### FLOJET

BIB Syrup Pump Accessories	110
BIB Syrup Pump Fittings	111
BIB Syrup Pump, Electric	104
BIB Syrup Kits, T5000 Series	104
BIB Syrup Pumps, T5000 Series	105
BIB Syrup Pumps, G55 Series	106
BIB Syrup Pumps, G56 Beer Pumps	106
BIB Syrup Pumps, G80 Pulpjet Pump	106

### GIS - OTHER

BIB Connectors, Sanitizers and Adapters	102-103
BIB Flex Rack System, 44239-POWDER	93
BIB Rack Shelves	90-92
BIB Pre-Built and Custom Built Rack Systems	94-97
BIB Syrup Pump Kits	104
Changeover-Valve and Backflow Preventer	115
Digital Refractometer for FCB Machines	109
Ice Scoops	20
Installation Kits, BIB	100-101
Nickel-Safe Ice Machine Cleaner	86

Ice-O-Matic, John Guest, McCanns, Oetiker,  
SHURflo, Taprite, and Wunder-Bar  
[Next Page](#)



## Index by Vendor

Page

### ICE-O-MATIC

Hotel Ice Dispensers, CD Series	18
Ice and Water Dispensers, IOD Series	16-17
Ice Machine Magnetic Air Filters	20
Ice Machine, Cube, Elevation Series	2-4
Ice Machine, Cube, Undercounter	5
Ice Machine, Flake, MFI Series	9
Ice Machine, Pearl, Countertop	7
Ice Machine, Pearl, GEM Series	6
Ice Machine, Pearl, Undercounter	7
Ice Maker Adaptor Chart for Bin Application	12-15
Ice Maker Adaptor Chart for Ice-Drink Application	32-34
Ice Storage Bins	11
Ice Storage Bin Accessories	20
Nickel-Safe Ice Machine Cleaner	86
Precharged Tubing Kits (Line Sets)	10
Remote Condenser Grill Guard Kits	10
Remote Condensers, RCA and RGA Series	10
Water Filtration Systems, Ice Machines	44-45

### JOHN GUEST

Beverage System Fittings	115-116
--------------------------	---------

### McCANN'S

1522, 2323, 3023 Drop-In Stand	22
BIB Air Pumping Stations	98
Big Mac Carbonator	41
Carbonator Pump Saver and Wall Mounted Shelf	42
Enduro Stands	30
Economy Water Boosters	98
Ice Tainer Leg Assemblies	25

### OETIKER

Oetiker Clamp Pincer, Pliers	114
Stepless Ear Clamps	114

### SHURFLO

Automatic Selector Valves	108
BIB Syrup Pump Fittings	112
BIB Syrup Pumps, Heavy Duty Advantage Series	107
Brix Pumps	107
Water Boost Systems	99

### TAPRITE

CO2 Management Systems	118
CO2 Primary Regulators for Soda Systems	117-118
CO2 Regulator Accessories and Parts	118, 121-122
CO2 Secondary Regulators for Soda Systems	118
Ice Chests and Ice Tainers	24, 27
Ice Tainer Leg Assemblies	24, 27
Tea Dispensers, Multi-Valve	73

### WUNDER-BAR

Bar Guns, Energy Drink	85
Bar Guns, Juice	85
Bar Guns, Post-Mix, Flow Control, Black	82
Bar Guns, Post-Mix, Mechanical Control, Black	83
Bar Guns, Post-Mix, No Manifold, Black	84
Bar Guns, Pre-Mix	85

Take a look at our  
2024 Dealer Catalog



**ELEVATION SERIES**



CIM0330  
CIM0430  
CIM0436  
CIM0530  
CIM0636

- Plastic food zone parts snap in and out and are dishwasher safe.
- Easily remove water distribution tube for cleaning. Also dishwasher safe.
- **Dual exhaust** selection from the side or top of every CIM unit.
- One-touch cleaning to sanitize or de-lime. LEDs alert for cleaning.

30" Width x 24.25" Depth x 21.25" Height



Model	CUBE SIZE Options		COOLING Options			Low and High value of Ice Production in 24hrs (LBS)	Voltage
	Full Cube	Half Cube	Air	Water	Remote		
CIM0330__	✓	✓	●	●		244-313#	115/60/1
CIM0430__	✓	✓	●	●		320-435#	115/60/1
CIM0436__	✓	✓	●	●		350-465#	208-230/60/1
CIM0530__	✓	✓	●	●	●*	432-561#	115/60/1
CIM0636__	✓	✓	●	●	●*	455-600#	208-230/60/1



CIM0320  
CIM0520  
CIM0526

**Ice-O-Matic**  
Ice. Pure and Simple

22" Width x 24.25" Depth x 21.25" Height

CIM0320__	✓	✓	●	●		244-313#	115/60/1
CIM0520__	✓	✓	●	●		432-561#	115/60/1
CIM0526__	✓	✓	●			445-555#	208-230/60/1

CIM0836  
CIM1136  
CIM1137



30" Width x 24.25" Depth x 26.9" Height

CIM0836__	✓	✓	●	●	●*	711-896#	208-230/60/1
CIM1136__	✓	✓	●	●	●*	762-932#	208-230/60/1
CIM1137__	✓	✓	●	●	●*	757-917#	208-230/60/3

Note: The ice production values given above are based on half-cube, air-cooled models. Water cooled units produce more and remote cooled (in some models) or full cube units produce less. Additionally, air temperature where unit is located may have an impact on the ice production values regardless of model or type.

**Important: When installing a CIM unit on a drink dispenser, the KCUBEDISP MUST be used.**

\* Remote condensers and line sets are required for remote-cooled ice makers.

**ELEVATION SERIES**



**Ice-O-Matic**

Ice. Pure and Simple

CIM1146  
CIM1147  
CIM2046  
CIM2047



48" Width x 24.25" Depth x 26" Height

Model	CUBE SIZE Options		COOLING Options			Low and High value of Ice Production in 24hrs (LBS)	Voltage
	Full Cube	Half Cube	Air	Water	Remote		
CIM1446__	✓	✓	●	●	●*	1210-1560#	208-230/60/1
CIM1447__	✓	✓	●	●	●*	1210-1560#	208-230/60/3
CIM2046__	✓	✓	●	●	●*	1470-1810#	208-230/60/1
CIM2047__	✓	✓	●	●	●*	1470-1810#	208-230/60/3



CIM0826  
CIM1126

**Best bang for the buck**

22" Width x 24.25" Depth x 26.9" Height

CIM0826__	✓	✓	●	●	●*	711-896#	208-230/60/1
CIM1126__	✓	✓	●	●	●*	762-932#	208-230/60/1

30" Width x 24.25" Depth x 26.9" Height

CIM0836GA	GRANDE CUBE	Air				645-800#	208-230/60/1
-----------	-------------	-----	--	--	--	----------	--------------

**Modular Cube Ice Maker Accessories**

Item #	Description	
BPF-1	Filler Panel Kit with 30" CIM, GEM, and ICE Series Cube Ice Makers for B110 bin only	Stocked
KBT5C	Bin Kit for 30" CIM, GEM, or ICE Series Cuber including ICE1506 Series for B100 bin	Stocked
KBT23C	Bin Kit for (1) 22" CIM, (1) MFI, or (1) GEM Series Ice Makers on a B110 bin	Stocked
KBT222	Bin Kit for (2) 22" CIM, (2) MFI, or (2) GEM Series Ice Makers on a B110 bin	Stocked
KCUBEDISP	Bin-level kit for Cornelius or Lancer dispenser with 30" CIM or the ICE1506	Stocked

Note: The ice production values given above are based on half-cube, air-cooled models. Water cooled units produce more and remote cooled (in some models) or full cube units produce less. Additionally, air temperature where unit is located may have an impact on the ice production values regardless of model or type.

**Important: When installing a CIM unit on a drink dispenser, the KCUBEDISP MUST be used.**

\* Remote condensers and line sets are required for remote-cooled ice makers.

See page 10 for remote condensers  
See page 11 for ice storage bins  
See page 12 for bin adapter chart



# CIM0826 & CIM1126 CUBE ICE MAKERS

**Best Bang for the**



22" Width x 24.25" Depth x 26.9" Height

**22-inch footprint with HIGH ICE PRODUCTION!  
Beats any other Ice Maker in its class.**



<i>Model</i>	CUBE SIZE Options		COOLING	Low and High value of Ice Production in 24hrs (LBS)	Voltage
	Full Cube	Half Cube	Air		
CIM0826_A	✓	✓	●	711-896#	208-230/60/1
CIM1126_A	✓	✓	●	762-932#	208-230/60/1

Note: The ice production values given above are based on half-cube, air-cooled models. Water cooled units produce more and remote cooled (in some models) or full cube units produce less. Additionally, air temperature where unit is located may have an impact on the ice production values regardless of model or type.

**Important:** When installing a CIM unit on a drink dispenser, the KCUBEDISP MUST be used.

- Plastic food zone parts snap in and out and are dishwasher safe.
- Easily remove water distribution tube for cleaning. Also dishwasher safe.
- Dual exhaust from the side or top of every CIM unit.
- One-touch cleaning to sanitize or de-lime. LEDs alert for cleaning.
- Exceeds DOE (Department of Energy) regulations.
- Up to 20% more energy efficient than other models.
- Universal Smart Harness - simplifies installation and servicing.

**Ice-O-Matic**  
Ice. Pure and Simple

Single Head Install	
Bin Model	Required Adaptor
B25PP	KBT19C
B40PS	KBT19C
B42PS	Not required
B55PS	KBT19C
B110PS	KBT23C

Twin Head Install	
Bin Model	Required Adaptor
B25PP	N/A
B40PS	N/A
B42PS	N/A
B55PS	N/A
B110PS	KBT222



**800-322-4853**

**ELEVATION SERIES**

**ICE SERIES**





ICEU070A







ICEU150  
ICEU220  
ICEU226



ICEU300

<u>Model</u>	15.2" Width x 23.6" Depth x 34.2" Height			Application Bin Storage (LBS)	Low and High value of Ice Production in 24hrs (LBS)	Voltage
<b>ICEU070A</b>				24#	66-84#	115/60/1

CUBE SIZE Options		COOLING Options		Application Bin Storage (LBS)	Low and High value of Ice Production in 24hrs (LBS)	Voltage
						
<b>Full Cube</b>	<b>Half Cube</b>	<b>Air</b>	<b>Water</b>			

<u>Model</u>	24.54" Width x 26.27" Depth x 39" Height				Application Bin Storage (LBS)	Low and High value of Ice Production in 24hrs (LBS)	Voltage
<b>ICEU150__</b>	✓	✓	●	●	70#	130-185#	115/60/1
<b>ICEU220__</b>	✓	✓	●	●	70#	175-238#	115/60/1
<b>ICEU226__</b>	✓	✓	●	●	70#	168-241#	208-230/60/1

<u>Model</u>	30.34" Width x 29.97" Depth x 39" Height				Application Bin Storage (LBS)	Low and High value of Ice Production in 24hrs (LBS)	Voltage
<b>ICEU300__</b>	✓	✓	●	●	97#	205-309#	115/60/1

Note: The ice production values given above are based on half-cube, air-cooled models. Water cooled units produce more or full cube units produce less. Additionally, air temperature where unit is located may have an impact on the ice production values regardless of model or type.

[The ICEU Models include power cordsets.](#)

<b>Part # 3P732-5</b>	● Leak proof, rustproof.
High Capacity Sump Pump	● ABS plastic tank
	● 3/8" OD barbed discharge
	● 6' power cord
	● Thermal overload protection

**Ice-O-Matic**  
Ice. Pure and Simple

GEM SERIES



# Soft Chewable Nuggets

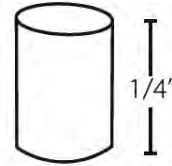

COOLING Options			Low and High value of Ice Production in 24hrs (LBS)	Voltage
Air	Water	Remote		

Model

21" Width x 24" Depth x 27" Height

GEM0450	●	●		464-354#	115/60/1
GEM0650	●	●	●*	500-740#	115/60/1
GEM0956	●	●	●*	753-1053#	208-230/60/1
GEM1306	●	●	●*	1000-1350#	208-230/60/1

30" Width x 24" Depth x 27" Height

GEM2006R			●*	1635-1960#	208-230/60/1
----------	--	--	----	------------	--------------



Note: The ice production values given above are based on air-cooled models. Water cooled units produce more and remote cooled (in some models) produce less. Additionally, air temperature where unit is located may have an impact on the ice production values regardless of model or type.

**Important:** When installing a GEM unit on a drink dispenser, the KGEMDISP MUST be used.

\* Remote condensers and line sets are required for remote-cooled ice makers.

## Modular Pearl Ice Maker Accessories

Item #	Description	
KBT19C	Bin Kit for (1) GEM or (1) MFI Series on a 30" Bin	Stocked
KBT24	Bin Kit for (1) GEM or (1) MFI Series on a 22" bin	Stocked
KBT23C	Bin Kit for (1) 22" CIM, (1) MFI, or (1) GEM Series Ice Makers on a B110 bin	Stocked
KBT222	Bin Kit for (2) 22" CIM, (2) MFI, or (2) GEM Series Ice Makers on a B110 bin	Stocked
KGEMDISP	Kit required for mounting a GEM to a Cornelius or Lancer dispenser	Stocked
1011520-11	Bin Kit for (2) 30" CIM, GEM, or MFI Series Ice Makers on a 60" bin only	N/S

N/S = Non-Stocked Item, requires special order and lead time.



Auger Assembly - the auger is all stainless steel machined with a one piece construction that reduces downward thrust and radial pressure.

**Ice-O-Matic**  
Ice. Pure and Simple





See page 10 for remote condensers  
See page 11 for ice storage bins  
See page 12 for bin adapter chart

**GEM SERIES**

*Soft Chewable Nuggets*

Model

			Application Bin Storage (LBS)	Low and High value of Ice Production in 24hrs (LBS)	Voltage
<b>GEMU090</b>		 <b>Air</b>	22#	60-85#	115/60/1





14.875" Width x 23.875" Depth x 33.375" Height (can add 1" to height with leg adjustment)

- Chewable ice in a convenient undercounter model
- Exclusive Pure Ice technology ensures fresh odor-free ice everytime
- Great for suites, break rooms, offices, and cafes
- Up to 85 lbs production and 22 lbs storage capacity
- Quiet operation
- Simple 115-volt plug-in design
- Two years Parts and Labor
- Optional sump pump kit available (Item # KPU090)



Ice Water Dispenser

Model

			Application Bin Storage (LBS)	Low and High value of Ice Production in 24hrs (LBS)	Voltage
<b>GEMD270A2</b>		 <b>Air</b>	12#	198-273#	115/60/1



15.5" Width x 25.5" Depth x 34.5" Height

- Chewable ice crystals in an ice water dispenser
- Space saving 15" wide design
- Idea for healthcare, cafeteria, restaurant, and office applications
- Up to 273 lbs production and 12 lbs storage capacity
- Quiet operation
- Touch-Free Dispense - infrared actuation
- Two years Parts and Labor (5-year part on compressor)
- Lighted key-pad for easy dispensing selection

500 and 700 SERIES

**CHUNKLET ICE**  
*Soft Chewable Nuggets*



- Continuous chunklet
- Stainless steel cabinet

COOLING Options			Low and High value of Ice Production in 24hrs (LBS)	Voltage
Air	Water	Remote		

\* Model                      Part #

14.5" Width x 25" Depth x 24.5" Height

<a href="#">WCC500A</a>	569200018	●			285-369#	115/60/1
<a href="#">WCC700A</a>	631600116	●			513-616#	115/60/1
<a href="#">WCC700W</a>	569200026		●		513-616#	115/60/1
<a href="#">WCC700R</a>	569200079			●*	513-616#	115/60/1
					* Use remote condenser # 638090690	

Note: Air temperature where unit is located may impact the ice production values regardless of model or type.

\* Remote condensers and line sets are required for remote-cooled ice makers.

**Remote Condensers for Cornelius Units**

Model #	Part #	Description
WCU600	638090690	Remote condenser for WCC700R

\* For use with Ice/Bev Combos only.

Reason: Adaptor kits for ice storage bin application is no longer produced by Cornelius.

WCC units will only fit on appropriate sized soda fountains.

Ask a sales person for guidance on this matter.

MFI SERIES

**Ice-O-Matic**  
Ice. Pure and Simple



Model

COOLING Options			Low and High value of Ice Production in 24hrs (LBS)	Voltage
Air	Water	Remote		

21" Width x 24" Depth x 27" Height

<b>MFI0500</b>	●	●		380-540#	115/60/1
<b>MFI0800</b>	●	●	●*	665-900#	115/60/1
<b>MFI1256</b>	●	●	●*	885-1149#	208-230/60/1
<b>MFI1506</b>	●		●*	1050-1450#	208-230/60/1

30" Width x 24" Depth x 27" Height

<b>MFI2306R</b>			●*	1845-2250#	208-230/60/1
-----------------	--	--	----	------------	--------------



Note: The ice production values given above are based on air-cooled models. Water cooled units produce more and remote cooled (in some models) produce less. Additionally, air temperature where unit is located may have an impact on the ice production values regardless of model or type.

\* Remote condensers and line sets are required for remote-cooled ice makers.

See page 10 for remote condensers  
See page 11 for ice storage bins  
See page 12 for bin adapter chart

**Modular Flaker Ice Maker Accessories**

Item #	Description	
KBT19C	Bin Kit for (1) GEM or (1) MFI Series on a 30" Bin	Stocked
KBT-24	Bin Kit for (1) GEM or (1) MFI Series on a 22" bin	Stocked
KBT23C	Bin Kit for (1) 22" CIM, (1) MFI, or (1) GEM Series Ice Makers on a B110 bin	Stocked
KBT222	Bin Kit for (2) 22" CIM, (2) MFI, or (2) GEM Series Ice Makers on a B110 bin	Stocked
KGEMDISP	Kit required for mounting a GEM to a Cornelius or Lancer dispenser	Stocked
1011520-11	Bin Kit for (2) 30" CIM, GEM, or MFI Series Ice Makers on a 60" bin only	N/S

N/S = Non-Stocked Item, requires special order and lead time.

*We stock and sell parts and accessories for all brands and models we represent.*



## RCA and RGA SERIES

### RCA Remote Condensers

Model #	Remote Condensers for use with Models	Dimensions (W x D x H)	Voltage
<b>RCA-1001</b>	CIM0530R	30.85" x 27" x 37"	115/60/1
<b>RCA-1061</b>	CIM0636R	30.85" x 27" x 37"	208-230/60/1
<b>RCA-2061</b>	CIM0826R, CIM0836R, CIM1126R, CIM1446, ICE1506R, GEM2006R, and MFI2306R	30.85" x 27" x 41.79"	208-230/60/1
<b>RCA-3561</b>	CIM2046R	30.85" x 27" x 41.79"	208-230/60/1



Image depicts a remote condenser with Grill Guard Kit installed.

- Lightweight construction and an aluminum coil help reduce weight by nearly 20% compared to previous models.
- Condenser fits through a standard 30" x 36" roof hatch for ease of installation.
- Easy assembly and installation with innovative legs.
- More efficient motor reduces energy usage by 25% - 50%.
- Environmentally responsible — all remote condensers use R404A, an approved non-ozone depleting refrigerant.
- Constructed from sturdy, corrosion-resistant galvanized steel.
- Reduces air conditioning requirements and cost.
- Fan is located outside, ensuring quiet operation for customers.

See page 2-4, 6, 9 for ice makers

### RGA Remote Condensers

Model #	Remote Condensers for use with Models	Dimensions (W x D x H)	Voltage
<b>RGA0501-HM</b>	GEM0650R and MFI0800R	30.85" x 27" x 37"	115/60/1
<b>RGA-1061-HM</b>	GEM0956R, GEM1306R, MFI1506R, and MF1256R	30.85" x 27" x 37"	208-230/60/1

### Remote Condenser Accessories

Item #	Description	
RT-325-404	25-ft Precharged Tubing Kit for units using R404A refrigerant	Stocked
RT-340-404	40-ft Precharged Tubing Kit for units using R404A refrigerant	Stocked
RT-375-404	75-ft Precharged Tubing Kit for units using R404A refrigerant	Stocked
GRILL10	Optional Grill Guard Kit for RCA-1001, RCA-1061, RGA-0501-HM and RGA-1061-HM	Stocked
GRILL20	Optional Grill Guard Kit for RCA-2061, RCA-3561	Stocked
GRILL30	Optional Grill Guard Kit for RCA-3061	N/S



Precharged Tubing Kit

## Ice Storage Bins

See page 2-4, 6, 9 for ice makers  
See page 12 for adaptor chart

## Ice Storage Bins



Bin Storage  
242 lbs

**B25**

30" W x 31" D x 28" H



Bin Storage  
344 lbs

**B40**

30" W x 31" D x 37.5" H



Bin Storage  
351 lbs

**B42**

22" W x 31" D x 50" H



Bin Storage  
510 lbs

**B55**

30" W x 31" D x 50" H



Bin Storage  
854 lbs

**B110**

48" W x 31" D x 50" H



Bin Storage  
680 lbs

**B700-30**

30" W x 31" D x 60" H



Bin Storage  
1000 lbs

**B1000-48**

48" W x 31" D x 56" H



Bin Storage  
1320 lbs

**B1300-48**

48" W x 31" D x 65" H



Bin Storage  
1325 lbs

**B1325-60**

60" wide model  
60" W x 31" D x 56" H



Bin Storage  
1660 lbs

**B1600-60**

60" wide model  
60" W x 31" D x 65" H

**Ice-O-Matic**

Ice. Pure and Simple

Note: Part # 1011520-11, bin kit is required when mounting (2) 30" CIM, GEM, or MFI models to a 60" wide bin.

## Bin Accessories

Item #	Description	
KLSCO	82 ounce ice scoop *	N/S
KSSCO	16 ounce ice scoop *	N/S
KSHOV	Plastic shovel	N/S
KSHOB	Bracket shovel	N/S
KICEP	Plastic paddle	N/S
KPBRA	Bracket paddle	N/S

\* Ice scoop sold separately for B700-30, B1000-48, B1300-48, B1325-60, and B1600-60 models.

Note: Ice maker not included (sold separately)



### Ice Maker Adapter Chart for Bin Application

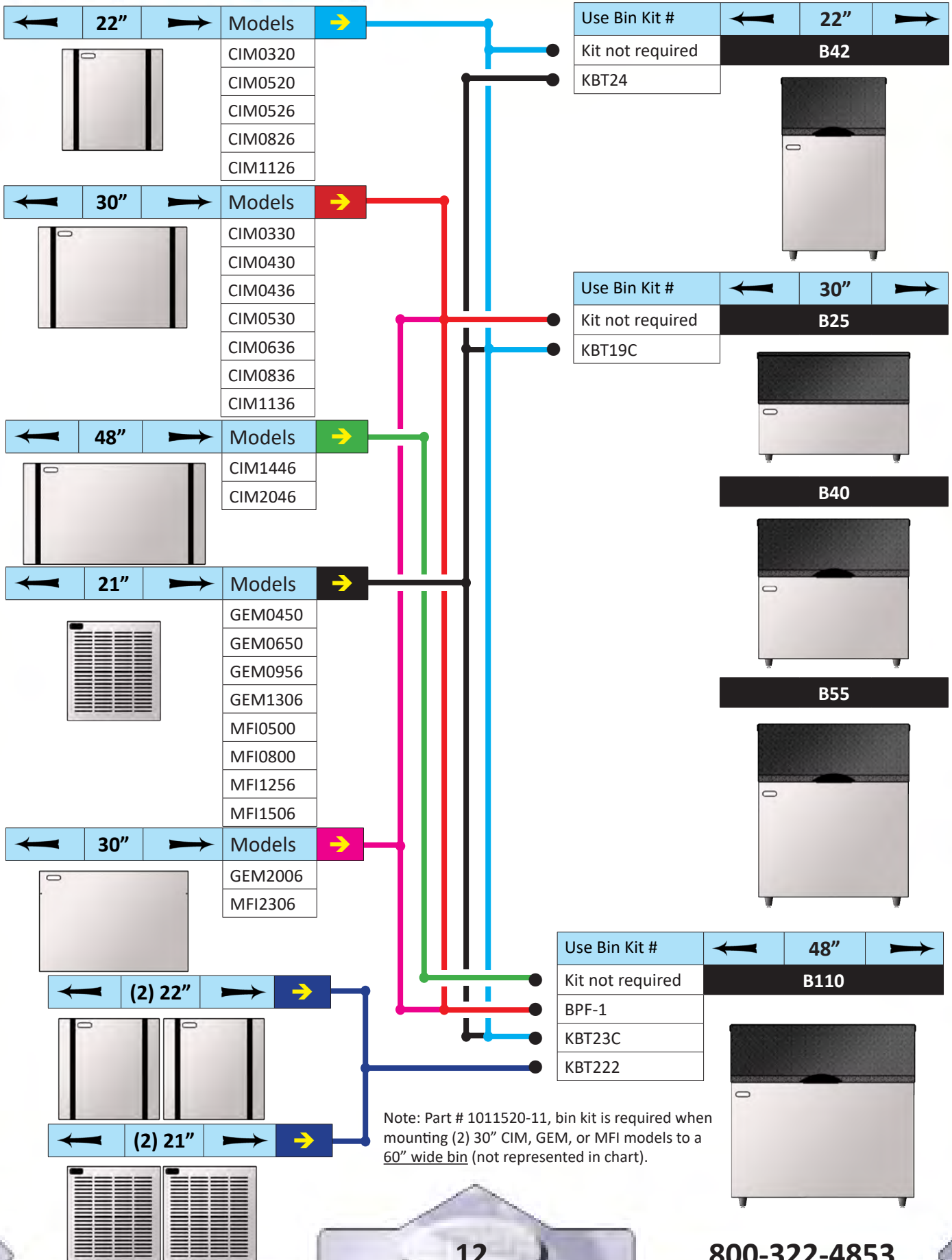

Note: Part # 1011520-11, bin kit is required when mounting (2) 30" CIM, GEM, or MFI models to a 60" wide bin (not represented in chart).

**Ice-O-Matic**  
Ice. Pure and Simple

<p><b>Part # KBT19C</b></p> <p>21" GEM/MFI Ice maker or 22" CIM Ice maker</p> <p>on a 30" Ice Storage Bin</p> 	<p><b>Part # KBT23C</b></p> <p>21" GEM/MFI Ice maker or 22" CIM Ice maker</p> <p>on a 48" B110 Ice Storage Bin</p> 	<p><b>Part # KBT24</b></p> <p>21" GEM/MFI Ice maker</p> <p>on a 22" B42 Ice Storage Bin</p> 
<p><b>Part # KBT222</b></p> <p>Two (2) 21" GEM/MFI or Two (2) 30" CIM</p> <p>on a 60" Wide Ice Storage Bin</p> 	<p><b>Part # BPF-1</b></p> <p>Bin Filler Kit for 30" CIM/GEM/MFI</p> <p>on a 48" B110 Ice Storage Bin</p> 	<p><b>Part # KBT5</b></p> <p>30" CIM/GEM/MFI/ICE Series</p> <p>on a 48" B100 Ice Storage Bin</p> 

Note: Part # 1011520-11, bin kit is also required when mounting (2) 30" CIM, GEM, or MFI models to a 60" wide upright bin.

**Ice-O-Matic**  
Ice. Pure and Simple

### Ice Maker Adapter Chart for Ice / Drink Dispensers

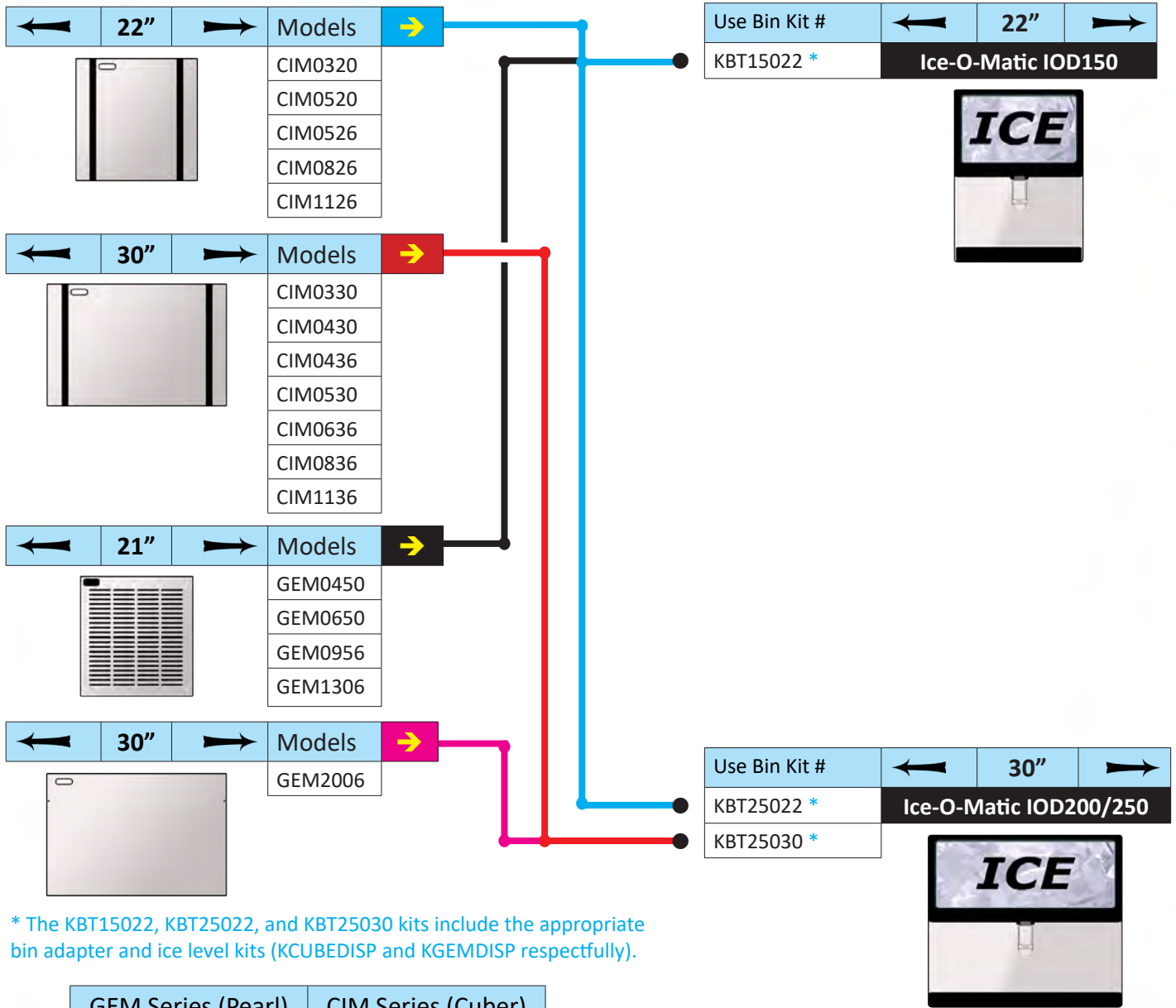

\* The KBT15022, KBT25022, and KBT25030 kits include the appropriate bin adapter and ice level kits (KCUBEDISP and KGEMDISP respectfully).

GEM Series (Pearl)	CIM Series (Cuber)
<b>Use KGEMDISP</b>	<b>Use KCUBEDISP</b>
(Ice Level Control)	(Ice Level Control)



An additional adapter kit must be provided by dispenser manufacturer (Lancer, Servend, etc...) if other than a Cornelius branded Ice-Beverage Combo.

See page 32-34 for ice maker adapter charts related to Cornelius

## Ice Maker Adapters for Ice Dispensers

**Ice-O-Matic**  
Ice. Pure and Simple



<b>Part # KBT15022</b>
Adapter and Bin Level Kit for 22" CIM or 21" GEM on an IOD150

Stocked

<b>Part # KBT25022</b>
Adapter and Bin Level Kit for 22" CIM or 21" GEM on an IOD200/250

Stocked

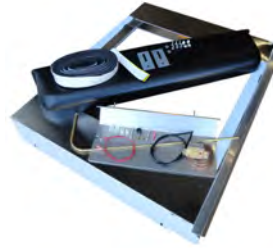
<b>Part # KBT25030</b>
Adapter and Bin Level Kit for 30" CIM or 30" GEM on an IOD200/250

Stocked

<b>Part # KCUBEDISP</b>
Bin Level Kit for a 30" CIM Series Icemaker on a Cornelius or Lancer Disp.

Stocked

<b>Part # KGEMDISP</b>
Mounting Kit for GEM Series Icemaker on a Cornelius or Lancer Disp.

Stocked



**Ice-O-Matic**  
Ice. Pure and Simple

Ice Only Dispensers (IOD SERIES)



IOD150



IOD200



IOD250

<i>Model</i>		ARI Bin Storage (LBS)	Voltage
<b>IOD150</b>	Cup Activated	150#	115/60/1
<b>IOD200</b>	Cup Activated	200#	115/60/1
<b>IOD250</b>	Cup Activated	250#	115/60/1

22.25" Width x 30.688" Depth x 35.625" Height

30.25" Width x 35.688" Depth x 35.625" Height

30.25" Width x 39.688" Depth x 39.625" Height

- Cup clearance is 10".
- Ultra-low profile design.
- User friendly push-to-dispense operation.
- Quick stop - prevents ice overflow and waste.
- Interlock safety switch turns off machine agitator when access panel is removed to allow easy cleaning of machine.
- 1" foam-insulation for maximum ice preservation (reduces quick melting of ice).
- Corrosion-resistant stainless steel and fingerprint-proof plastic.
- Auto Rotate Agitator - turns the ice every hour to provide more dispensable ice.

**Ice-O-Matic**  
Ice. Pure and Simple

For use with Ice-O-Matic cuber or pearl (nugget) ice makers



Note: Ice maker not included (sold separately)

IOD Accessories

Item #	Description	
KBT15022	Adaptor and bin-level kit for a 22" cuber or nugget ice maker on IOD150	Stocked
KBT25030	Adaptor and bin-level kit for a 30" cuber ice maker on IOD200/250	Stocked
KBT25022	Adaptor and bin-level kit for a 22" cuber or nugget ice maker on IOD200/250	Stocked
<b>KWGFID</b>	Water glass filler kit for an IOD150/200/250 or CD40022 (Field installed only)	<b>N/S</b>
<b>9131040-01</b>	Water glass filler kit for an IODXXX Series, IMD Series and EDXXX IOD Series	Stocked
KGEMDISP	Kit required when mounting GEM to a beverage dispenser (Cornelius or Lancer)	Stocked
KCUBEDISP	Bin-level kit for a Cornelius or Lancer dispenser with a 30" CIM or with the ICE1506	Stocked

N/S = Non-Stocked Item, requires special order and lead time.

Enduro Ice Only Dispensers



**ED150**



**ED200**



**ED250**



**ED300**

<u>Model</u>		Bin Storage (LBS)	Voltage	
<b>ED150 IOD</b>	Cup Activated	150#	115/60/1	22" Width x 30" Depth x 35.62" Height
<b>ED200 IOD</b>	Cup Activated	200#	115/60/1	30" Width x 30" Depth x 35.62" Height
<b>ED250 IOD</b>	Cup Activated	250#	115/60/1	30.69" Width x 30" Depth x 36.94" Height
<b>ED300 IOD</b>	Cup Activated	300#	115/60/1	44.62" Width x 30" Depth x 37" Height

<u>Model</u>	Part Number	
<b>ED150 IOD</b>	621022460	
<b>ED200 IOD</b>	621022560	
<b>ED250 IOD</b>	621022740	
<b>ED300 IOD</b>	621024560	

Note: If legs are installed, height is increased by 4"  
 Note: Ice maker not included (sold separately)



- Cup clearance is 10".
- Water valve option is available.
- Rounded stainless steel exterior provides a stylish appearance.
- Insulated drip tray prevents condensation.
- Enduro 150, 200, 250 include 4" legs (ED300 leg set sold separately).
- All components accessible from front of unit.
- One-piece ABS thermoformed plastic ice hopper (Durabide design) provides durability and ensures all ice in hopper is dispensable.

ED Ice Dispenser Accessories

Item #	Description	
08017	Leg kit for Enduro 300 Ice Dispenser (includes (6) 4" legs)	<b>N/S</b>
01917	Water glass filler kit for Enduro Ice Dispensers (Field installed only)	<b>N/S</b>
<b>9131040-01</b>	Water glass filler kit for an IODXXX Series, IMD Series and EDXXX IOD Series	Stocked

N/S = Non-Stocked Item, requires special order and lead time.

See page 2-4, 6, 9 for ice makers  
 See page 32-33 for adapter chart



### CD SERIES



CD40022



CD40030



CD40130

# Ice-O-Matic

Ice. Pure and Simple



#### Model

Model	ARI Bin Storage (LBS)	Voltage
CD40022	120#	115/60/1
CD40030	180#	115/60/1
CD40130	180#	115/60/1

22" Width x 33.5" Depth x 53.25" Height  
 30" Width x 33.5" Depth x 53.25" Height  
 30" Width x 33.5" Depth x 53.25" Height

Note: CD40022 accepts 22" CIM cubers. CD40030 and CD40130 accepts 30" CIM cubers  
 Note: Ice maker not included (sold separately)

- Ice fill station clearance is 13.5" width x 8.5" depth x 8.75" height.
- Turbo Dispense drops 1/4 lbs of ice per second.
- User friendly push-to-dispense operation.
- The model CD40130 comes with water glass filler.
- Interlock safety switch turns off machine agitator when access panel is removed to allow easy cleaning of machine (no removal of top mounted ice maker).
- 4" foam-insulation for maximum ice preservation (reduces quick melting of ice).
- Corrosion-resistant stainless steel and fingerprint-proof plastic.
- Great for hard water, food safety, and tight spaces.



Requires top mounted ice maker installed to dispense ice.



CD40022 and CD40030

(Push for Ice without water dispenser)



CD40130

(Push for Ice WITH WATER DISPENSER)

**IMD Series**

**CHUNKLET ICE**  
*Soft Chewable Nuggets*

Dispense Options		Ice Bin Storage (LBS)	Low and High value of Ice Production in 24hrs (LBS)	Voltage
Push Button	Lever			

*Model*      *Part #*

15" Width x 24 Depth x 35" Height

<b>IMD300-15</b>	<b>638090701 *</b>	●		13	202-246#	115/60/1
* Includes Ice and Water Switch						

18.625" Width x 27.5" Depth x 35.75" Height

<b>IMD300-30</b>	<b>638090500</b>		●	30	301-360#	115/60/1
<b>IMD300-30</b>	<b>638090501</b>	●		30	301-360#	115/60/1

18.625" Width x 27.5" Depth x 35.75" Height

<b>IMD600-30</b>	<b>638090400</b>		●	30	493-618#	115/60/1
<b>IMD600-30</b>	<b>638090401</b>	●		30	493-618#	115/60/1

Note: Air temperature where unit is located may impact the ice production values regardless of model or type.



**IMD300-15**



**IMD300-30**  
**IMD600-30**



Lever Activated



Push Button

- Continuous chunklet
- Stainless steel cabinet
- Easy-clean air filters
- Durable design
- Energy efficient

**IMD Accessories**

Part #	Description	
638004615	4" adjustable leg kit	Stocked
638031243	Floor stand for IMD300-30 and IMD600-30 (19" W x 27" D x 29" H)	Stocked
<b>638031500</b>	Manual glass water filler kit	Stocked
<b>9131040-01</b>	Water glass filler kit for an IODXXX, IMD and EDXXX IOD	Stocked





Ice Machine and Ice Bin Accessories

CIM Series Air Filtration

<b>AFK-1 Magnetic Air Filter</b>
Part # <b>9131574-01</b>
For CIM300, 400, 500, and 600 Series

N/S

<b>AFK-2 Magnetic Air Filter</b>
Part # <b>9131574-02</b>
For CIM0826, 1126, 0836, and 1136 Series

Stocked

<b>AFK-3 Magnetic Air Filter</b>
Part # <b>9131574-03</b>
For CIM1446 and CIM2046 Series

N/S

- Made of durable UV protected polypropylene.
- Easily cleaned in place. Brush filter with stiff brush or vacuum.
- If clogged with greasy build-up, remove and spray with a mild detergent or flush with water hose.

Bin Accessories

Part #	Description	
KLSCO	82 ounce Ice Scoop	N/S
KSSCO	16 ounce Ice Scoop	N/S
KSHOV	Plastic Shovel	N/S
KSHOB	Bracket Shovel	N/S
KICEP	Plastic Paddle	N/S
KPBRA	Bracket Paddle	N/S



N/S = Non-Stocked Item, requires special order and lead time.

Part # <b>108-S20332</b>
Ice Scoop, Plastic

N/S

Part # <b>108-RICE0004</b>
Ice Scoop, Aluminum

Stocked



Ice Scoops

N/S = Non-Stocked Item, requires special order and lead time.

**1522 and 2323 Drop-In Dispensers (Post-Mix)**

Model	Part #	Number of UFB Valves	Cup Clearance	Ice Bin Capacity (LBS)	Required Cut Out (Measurements)	Cold Plate Circuits	Carb/ Non-Carb Manifold
<b>15" Width x 23" Depth x 33" Height</b>							
CB1522	631100045	6	9.75"	60 lbs	15.25" x 23.25"	Water 3, Syrup 6	4-1-1
<b>15" Width x 23" Depth x 37" Height</b>							
CB1522	631100046	6	9.75"	75 lbs	15.25" x 23.25"	Water 3, Syrup 6	4-1-1
<b>23" Width x 23" Depth x 33" Height</b>							
CB2323	631100049	6	9.75"	80 lbs	23.25" x 23.25"		5-1
CB2323	631100055	8	9.75"	80 lbs	23.25" x 23.25"		5-2-1
<b>23" Width x 23" Depth x 37" Height</b>							
CB2323	631100057	8	9.75"	100 lbs	23.25" x 23.25"		5-2-1



**CB1522**



**CB2323**

- Standard UFB-1 fast flow (2-4 oz) sanitary lever valves.
- Foamed polyurethane insulation.
- All stainless steel construction.
- Can be secured by key lock switch located on tower.
- Removable front and back panels on the dispensing tower.
- Wide drip tray provides staging area for cup and is easily removable.
- None of the models depicted above have a merchandiser.

Note: A lighted merchandiser is available for these models (sold separately) - ask a sales person for part #, pricing, and availability.



Note: See page 22 for drop-in stands that make these dispensers free-standing units.

1522, 1722, 2323 Ice Cooled Stands



Part #	Assembled or Unassembled	Description
--------	--------------------------	-------------

1522 Ice Cooled Drop-in Stands

<b>630001204</b>	<b>Unassembled</b>	1522 Drop-in Stand	17" Width x 25" Depth x 36.25" Height
<b>630001217</b>	<b>Assembled</b>	1522 Drop-in Stand	17" Width x 25" Depth x 36.25" Height

1722 Ice Cooled Drop-in Stands

<b>630001212</b>	<b>Unassembled</b>	1722 Drop-in Stand	24" Width x 18" Depth x 36.25" Height
<b>630001220</b>	<b>Assembled</b>	1722 Drop-in Stand	24" Width x 18" Depth x 36.25" Height

2323 Ice Cooled Drop-in Stands

<b>630001205</b>	<b>Unassembled</b>	2323 Drop-in Stand	25" Width x 25" Depth x 36.25" Height
<b>630001218</b>	<b>Assembled</b>	2323 Drop-in Stand	25" Width x 25" Depth x 36.25" Height

Note: Drop-in dispensers sold separately (See page 21).

- Ice Cooled Stands are for use with Ice Cooled Drop-in Dispensers.
- Stand converts an Ice Cooled Drop-in Dispenser to a freestanding unit.
- Stainless steel exterior.
- Each assembly includes (4) 6" die cast with nickel finished legs.



Ice Cooled Stand Accessories

Part #	Description
70407	6" Leg Set adjustable, 5/8-11 thread, 1.25" adjustable, nickel plated (this set contains qty of 4)

McCann's Drop-in Conversion Stands

Product #	Description	(W x D x H)
<b>16-1337</b>	1522 Drop-in Stand (15" x 22")	17" x 24" x 36"
<b>16-1321</b>	2323 Drop-in Stand (23" x 23")	25" x 25" x 36"
<b>16-1576</b>	3023 Drop-in Stand (30" x 23")	32" x 25" x 36"



- Stands are for use with Ice Cooled Drop-in Dispensers.
- Converts Drop-in Dispenser to a freestanding unit.
- Sturdy, stainless steel construction.
- Shipped knocked-down, but quick assembly.



16-1337



16-1321



16-1576

Note: Drop-in dispensers sold separately (See page 21).

**1522, 2123 Ice Chests and Ice Tainers**

Model	Part #	Cold Plate Configuration (if applicable)	Ice Bin Capacity (LBS)	Required Cut Out (Measurements)	Pre-Mix, Post-Mix, or None
<b>Drop-In (Custom)</b>		<b>15" Width x 23" Depth x 14" Height</b>			
<b>C1522</b>	<b>165234007</b>	8 Circuit	60 lbs	15.25" x 22.25"	Post-Mix
<b>Ice Tainer</b>		<b>15" Width x 23" Depth x 14" Height</b>			
<b>1522IT</b>	<b>162473003</b>	7 Circuit	60 lbs		Pre-Mix
<b>1522IT</b>	<b>162473004</b>	8 Circuit	60 lbs		Post-Mix
<b>Drop-In (Custom)</b>		<b>23" Width x 21" Depth x 14" Height</b>			
<b>C2123</b>	<b>162742002</b>	7 Circuit	80 lbs	21.25" x 23.25"	Pre-Mix
<b>C2123</b>	<b>162111004</b>	9 Circuit	80 lbs	21.25" x 23.25"	Post-Mix
<b>Drop-In (Custom)</b>		<b>23" Width x 21" Depth x 18" Height</b>			
<b>C2123</b>	<b>162111104</b>	9 Circuit	100 lbs	21.25" x 23.25"	Post-Mix
<b>Ice Tainer</b>		<b>23" Width x 21" Depth x 14" Height</b>			
<b>2123IT</b>	<b>162468002</b>	7 Circuit	80 lbs		Pre-Mix
<b>2123IT</b>	<b>162468003</b>	9 Circuit	80 lbs		Post-Mix
<b>Ice Tainer</b>		<b>23" Width x 21" Depth x 18" Height</b>			
<b>2123IT</b>	<b>162468103</b>	9 Circuit	100 lbs		Post-Mix

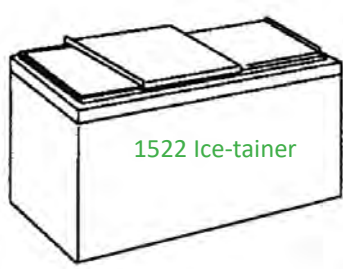
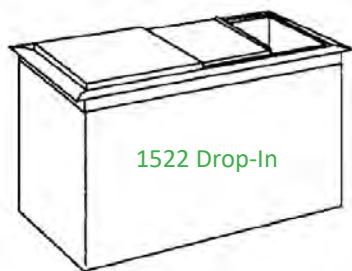

**Ice Tainers** can be used with legs (not included) (see ice-tainer leg assemblies - page 24-27), placed on a counter, table-top, or other support system.

**Drop-Ins** are placed into counters or bars (requires an open cut out per measurements as identified above).

1522, 2123 Ice Chests and Ice Tainers



Model	Cold Plate Configuration	Ice Bin Capacity (LBS)	Pre-Mix, Post-Mix	
<b>1522 Drop-In</b>		<b>15" Width x 22" Depth x 14.25" Height</b>		
DI-1522-7	7 Circuit	60 lbs	Pre-Mix	
DI-1522-8	8 Circuit	60 lbs	Post-Mix	
<b>1522 Ice Tainer</b>		<b>16.875" Width x 23.875" Depth x 14.25" Height</b>		
FS-1522-7	7 Circuit	60 lbs	Pre-Mix	Use LS-1522-KD Leg Stand
FS-1522-8LS	8 Circuit	60 lbs	Post-Mix	Comes with LS-1522-KD Leg Stand
<b>2123 Drop-In</b>		<b>22.75" Width x 24.75" Depth x 14.25" Height</b>		
DI-2123-7	7 Circuit	80 lbs	Pre-Mix	
DI-2123-9	9 Circuit	80 lbs	Post-Mix	
<b>2123 Ice Tainer</b>		<b>21" Width x 23" Depth x 14.25" Height</b>		
FS-2123-7	7 Circuit	80 lbs	Pre-Mix	Use LS-2123-KD Leg Stand
FS-2123-9LS	9 Circuit	80 lbs	Post-Mix	Comes with LS-2123-KD Leg Stand
<b>2123 Ice Tainer</b>		<b>21" Width x 23" Depth x 18.25" Height</b>		
FS-2123-9-100	9 Circuit	100 lbs	Post-Mix	

- Available as freestanding and drop-in models.
- All models come complete with lids.
- Sturdy, stainless steel construction.
- Foamed in place insulation.
- The FS-1522-8LS and FS-2123-9LS comes complete with leg stand.



Freestanding Ice Tainer



Drop-in Ice Chest



with legs



Part #	Description
--------	-------------

1522 Ice Tainer Leg Assembly

LS-1522-KD	1522 Ice Tainer Leg Assembly	15" Width x 22" Depth x 19.5" Height
------------	------------------------------	--------------------------------------

2123 Ice Tainer Leg Assembly

LS-2123-KD	2123 Ice Tainer Leg Assembly	23" Width x 21" Depth x 19.5" Height
------------	------------------------------	--------------------------------------

Taprite leg stands are for Taprite Ice Tainers only. Don't use with other manufacturer's models.



Leg Stand

Note: These leg assemblies are for use with the Taprite Ice Tainers above (sold separately, except where identified).  
 Note: Shipped knocked down, but easily assembled.



1522, 2123 Ice Tainer Leg Assemblies



Part #	Description
--------	-------------

1522 Ice Tainer Leg Assembly

<b>163328000</b>	1522 Ice Tainer Leg Assembly	15" Width x 22" Depth x 19.5" Height
------------------	------------------------------	--------------------------------------

2123 Ice Tainer Leg Assembly

<b>163329000</b>	2123 Ice Tainer Leg Assembly	23" Width x 21" Depth x 19.5" Height
------------------	------------------------------	--------------------------------------

Note: Ice Tainers sold separately (See page 23).

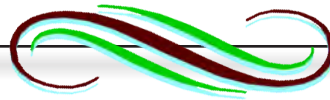

1522, 2123 Universal Leg Assemblies



Part #	Description
--------	-------------

1522 Universal Leg Assembly

<b>15-2898-UNIV</b>	1522 Universal Leg Assembly	For Cornelius or Lancer Ice Cooled Bins
---------------------	-----------------------------	---

2123 Universal Leg Assembly

<b>15-2897-UNIV</b>	2123 Universal Leg Assembly	For Cornelius or Lancer Ice Cooled Bins
---------------------	-----------------------------	---

Note: Ice Tainers and Ice Chests sold separately (See page 23).

- Universal for Ice Tainers or Ice Chests.
- Converts Ice Tainer or Ice Chest to a freestanding unit.
- Sturdy, stainless steel construction.
- Shipped unassembled, but quick assembly.



15-2898-UNIV



15-2897-UNIV



## ICE CHESTS WITH LEG KITS

# Ice Chest & Leg Kit Combo Units

Save space and freight costs!



Packaged in a Single Box



Ice Chest

Knock Down Leg Kit

### 741200014

Free Standing 1522 Ice Chest, 60#, 8 circuit, PSMX w/ knock down leg kit

### 741200011

Free Standing 2123 Ice Chest, 80#, 9 circuit, PSMX w/ knock down leg kit

### 741200033

Free Standing 2123 Ice Chest, 100#, 9 circuit, PSMX w/ knock down leg kit

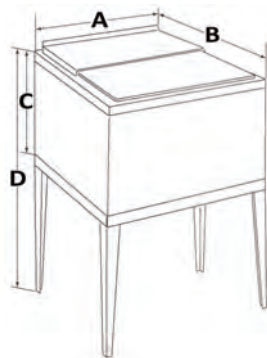

<u>Product</u>	<u>Ice Capacity</u>	<u>A</u>	<u>B</u>	<u>C</u>	<u>D</u>
1522	60 Lbs	15"2	2"	14"3	3.5"
2123	80 Lbs	21"2	3"	14"3	3.5"
2123	100 Lbs2	1"	23"1	8"	33.5"



Ice Chests and Leg Stands

**ICE CHESTS AND LEG STANDS**



Free Standing

**Ice Chest / Leg Stand Combo Kits**

Packaged in one box and palletized

**FS-1522-8LS**

Free Standing 1522 Ice Chest, 8 circuit, PSMX w/ knock down leg stand

**FS-2123-9LS**

Free Standing 2123 Ice Chest, 9 circuit, PSMX w/ knock down leg stand



Knock Down Leg Stand

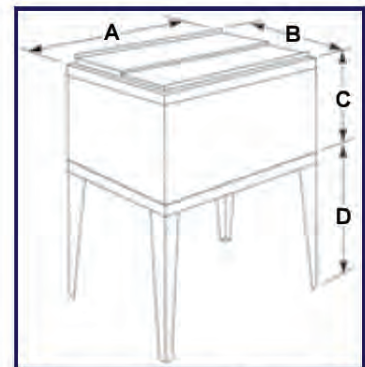

**Dimensions**

Options	Ice Capacity	A	B	C	D
1522	60lbs	22"	15"	14 1/4"	19 1/4"
2123	80lbs	23"	21"	14 1/4"	19 1/4"

**DROP-IN ICE CHESTS**

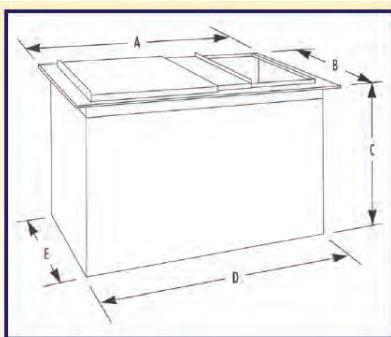

**Drop-In Options**

Options	Ice Capacity	A	B	C	D	E
1522	60lbs	16 7/8"	23 7/8"	14 1/4"	15"	22"
2123	80lbs	22 3/4"	24 3/4"	14 1/4"	21"	23"
2123	100lbs	22 3/4"	24 3/4"	18 1/4"	21"	23"



Drop-In

**DI-1522-8**

Drop-In 1522 Ice Chest, 8 circuit, PSMX

**DI-2123-9**

Drop-In 2123 Ice Chest, 9 circuit, PSMX



Enduro Ice and Beverage Combo Dispensers

Enduro

- All Enduro models have a 10" Cup Clearance.
- All Enduro models are 115/60/1 voltage.
- All UFB valves are 2-4 ounce dispense.
- All Enduro models on this page come with generic graphics.
- Branded ED models (Coca-Cola and Pepsi) with associated graphics are available but not shown in this catalog (ask a sales person for a specific brand-model).
- Flavor-Blast versions of 200, 250, and 300 models are available.
- All Enduro models use a TotalFlex Manifold.
- All Enduro models are Post-Mix.
- Enduro models 150, 200, and 250 come with legs (ED300 legs sold separately).

See page 2-4, 6, 9 for ice makers  
See page 32-34 for adapter chart

Model	Part #	Number of UFB Valves	Dispenser Type	Ice Bin Capacity (LBS)	TotalFlex Manifold
<b>ED150 Ice/Bev Combo</b>		<b>22" Width x 30" Depth x 35.625" Height</b>			
ED150BC	621053405	6	Sanitary Lever	150 lbs	3-1-2
<b>ED175 Ice/Bev Combo</b>		<b>24.5" Width x 30" Depth x 35.625" Height</b>			
ED175BC	621052703	8	Sanitary Lever	175 lbs	2-2-1-3
<b>ED200 Ice/Bev Combo</b>		<b>30" Width x 30" Depth x 35.625" Height</b>			
ED200BC	621053108	8	Sanitary Lever	200 lbs	2-2-1-3
ED200BC	621053107	10	Sanitary Lever	200 lbs	2-3-1-4
<b>ED250 Ice/Bev Combo</b>		<b>30" Width x 30" Depth x 39.625" Height</b>			
ED250BC	621052807	8	Sanitary Lever	250 lbs	2-2-1-3
ED250BC	621052806	10	Sanitary Lever	250 lbs	2-3-1-4
ED250BC	0528452	10	Push Button	250 lbs	2-3-1-4
<b>ED300 Ice/Bev Combo</b>		<b>44.375" Width x 30" Depth x 37" Height</b>			
ED300BC	02810	12	Sanitary Lever	300 lbs	3-1-2-3-1-2
ED300BC	02813	12	Push Button	300 lbs	3-1-2-3-1-2

Note: ED300 leg kit sold separately, reference part # 08017 (for use with manual fill units only, no top mounted IM).



Note: Ice maker not included (sold separately)

Enduro Ice and Beverage Combo Dispensers

- All Flavor Blast Enduro models have a 10" Cup Clearance.
- All Flavor Blast Enduro models are 115/60/1 voltage.
- All UFB valves are 2-4 ounce dispense.
- Flavor Blast Enduro models come with FB graphic.
- A 4-button Flavor Blast keypad is located on merchandiser and ADA keypad located on the lower panel.
- All FB Enduro models use a TotalFlex Manifold.
- All FB Enduro models are Post-Mix.
- Models 200, and 250 come with legs.

Enduro

with Flavor Blast and ADA Keypad

Model	Part #	Number of UFB Valves	Dispenser Type	Ice Bin Capacity (LBS)	TotalFlex Manifold	
<b>ED200 Ice/Bev Combo</b>		30" Width x 30" Depth x 35.625" Height				
ED200BC	621055177	10	Sanitary Lever	200 lbs	2-3-1-4	Non-Stocked, Special Order
<b>ED250 Ice/Bev Combo</b>		30" Width x 30" Depth x 39.625" Height				
ED250BC	621055181	8	Sanitary Lever	250 lbs	2-2-1-3	Non-Stocked, Special Order
ED250BC	621055182	10	Sanitary Lever	250 lbs	2-3-1-4	Non-Stocked, Special Order
<b>ED300 Ice/Bev Combo</b>		44.375" Width x 30" Depth x 37" Height				
ED300BC	621055176	12	Sanitary Lever	300 lbs	3-1-2-3-1-2	

Note: ED300 leg kit sold separately, reference part # 08017 (for use with manual fill units only, no top mounted IM).



ED200 Flavor Blast



ED250 Flavor Blast



ED300 Flavor Blast



Retrofit kits to convert existing Enduro models available for units with and without drip tray (Z-style) (See page 30).

Note: Ice maker not included (sold separately)

See page 2-4, 6, 9 for ice makers  
See page 32-34 for adapter chart

ADA Keypad provides ADA compliance on 34" countertops

POST-MIX

Enduro Stands and Accessories



3472

3470

3473



- Converts Ice Drink Dispenser to a freestanding unit.
- Available with 6" legs or 4" Casters.
- Sturdy, stainless steel construction.

Ice Drink Dispenser Stands with 6" Legs

Part #	Description	Measurements
<b>3472</b>	For ED150 6-Valve	22" W x 30" D x 30"
<b>3470</b>	For ED175 8-Valve	24.5" W x 30" D x 30" H
<b>3473</b>	For ED200/250 or IDC215/255	30" W x 30" D x 30" H



See page 28-29 for Enduro Dispensers  
See page 35 for IDC Dispensers

Ice Drink Dispenser Stands with Legs

Part #	Description
<b>16-1578</b>	22" Wide Ice-Bev Combo Stand
<b>16-1579</b>	30" Wide Ice-Bev Combo Stand

Note: Shipped preassembled.



16-1578



16-1579

Soft Ice Dispense Accessories for Enduro Models

Part #	Description	
629088514	ED150 or ED175 Agitator Kit for units that use Chunklet/Nugget Ice (kit includes agitator & ice diverter)	Stocked
629088508	ED200 Ice Slide Kit for Chunklet/Nugget Ice (kit includes ice diverter instructions and ice slide)	N/S
629088507	ED250 Ice Slide Kit for Chunklet/Nugget Ice (kit includes ice diverter instructions and ice slide)	N/S
629088644	ED300 Agitator Kit for units that use Chunklet/Nugget Ice (kit includes 2 agitators & 2 ice diverters)	Stocked
02394	Ice Diverter Kit to dispense pellet Ice in ED150, ED175, ED200, and ED250 models	Stocked

N/S = Non-Stocked Item, requires special order and lead time.

Enduro Flavor Blast Retro Fit Kits



629088377



629088380  
629088382  
629088384



629088386



629088392  
629088394



629088396

Flavor Blast Retro Fit Kits for Enduro Models

Part #	Description	
629088377	Converts ED150 to 2-Flavor FB black <u>with</u> FB graphic	N/S
629088380	Converts ED175 to 4-Flavor FB black <u>with</u> FB graphic	N/S
629088382	Converts ED200 to 4-Flavor FB black <u>with</u> FB graphic	Stocked
629088384	Converts ED250 to 4-Flavor FB black <u>with</u> FB graphic	N/S
629088386	Converts ED300 to 4-Flavor FB black <u>with</u> FB graphic	Stocked
629088392	Converts ED200 to 4-Flavor FB black without FB graphic	Stocked
629088394	Converts ED250 to 4-Flavor FB black without FB graphic	Stocked
629088396	Converts ED300 to 4-Flavor FB black without FB graphic	N/S

N/S = Non-Stocked Item, requires special order and lead time.

ADA Flavor Blast Retro Fit Kits for Enduro Models

- Kits only include lower splash panel with ADA keypad.
- Kit provides ADA compliance (where applicable).



629097122

Part #	Description	
629097119	Converts ED150 to ADA FB model (Use with FB retro kits listed above)	N/S
629097120	Converts ED175 to ADA FB model (Use with FB retro kits listed above)	N/S
629097121	Converts ED200/250 to ADA FB model (Use with FB retro kits listed above)	Stocked
629097122	Converts ED300 to ADA FB model (Use with FB retro kits listed above)	Stocked
629097123	Converts ED150 to ADA FB model (Use with FB retro kits listed above)	N/S
629097124	Converts ED150 without drip tray to ADA model (Use with FB retro kits listed above)	N/S
629097125	Converts ED200/250 without drip tray to ADA model (Use with FB retro kits listed above)	N/S
629097126	Converts ED300 without drip tray to ADA model (Use with FB retro kits listed above)	Stocked

N/S = Non-Stocked Item, requires special order and lead time.

Ice Maker Adapter Chart for Dispenser Application

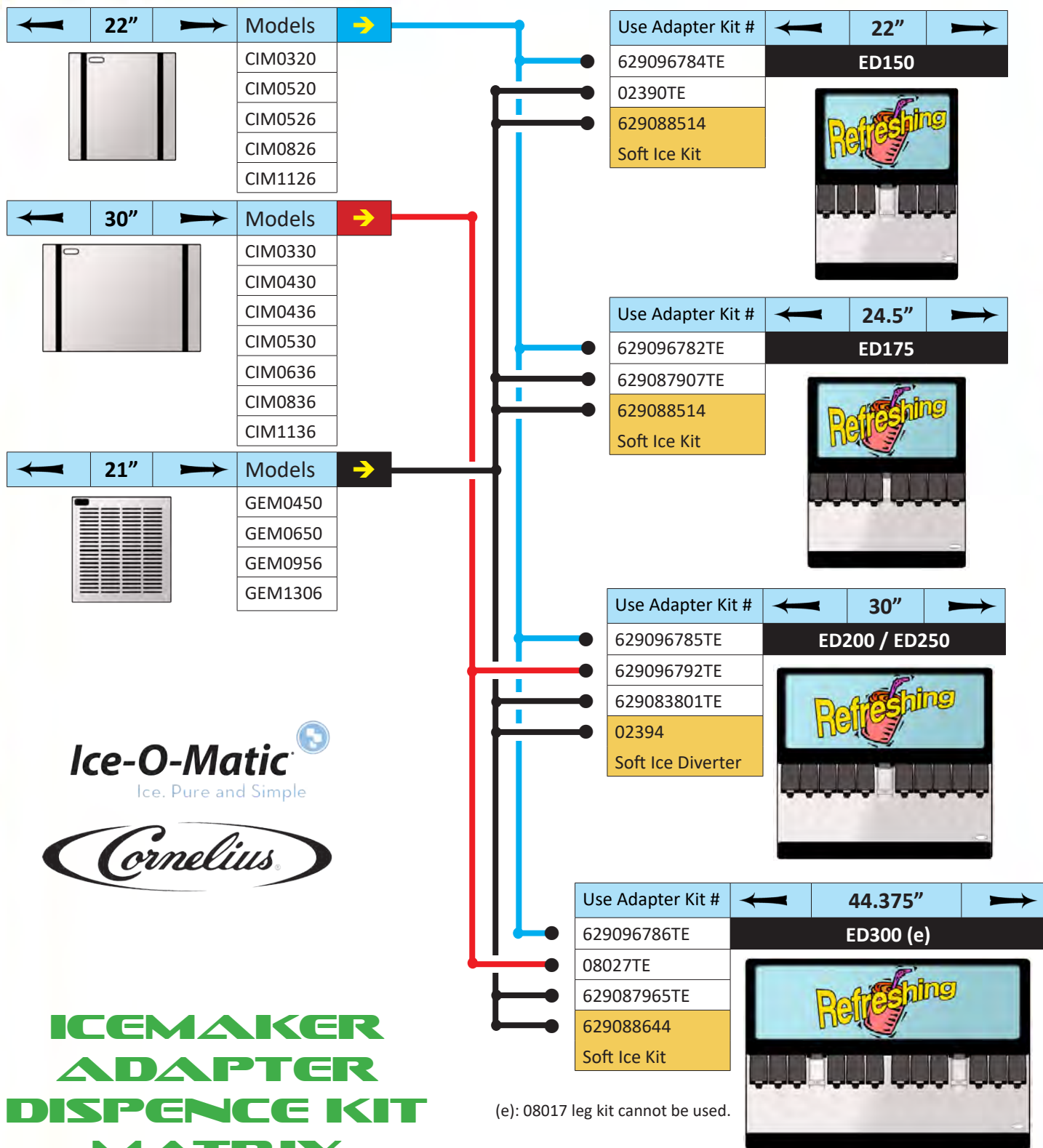

**Ice-O-Matic**  
Ice. Pure and Simple

*Cornelius*

**ICEMAKER  
ADAPTER  
DISPENSE KIT  
MATRIX**

(e): 08017 leg kit cannot be used.

Adapters for single Ice Maker Application Only.

See page 14-15 for Enduro Dispenser Adapters provided by Ice-O-Matic

# Ice Machine Adapter Kits

## 22" Wide CIM Cuber Icemaker \*

ICE/BEV MODEL		ADAPTER #
ED150		02390TE
ED175		629087907TE
ED200		629096785TE
ED250		629096785TE
ED300		629096786TE
FlavorFusion		629097706
Flavor Overload		629097706
IDC PRO		INCLUDED

## 30" Wide CIM Cuber Icemaker \*

ICE/BEV MODEL		ADAPTER #
ED150		N/A
ED175		N/A
ED200		08006TE
ED250		08006TE
ED300		08027TE
FlavorFusion		629097706
Flavor Overload		629097706
IDC PRO		INCLUDED

## 21" Wide GEM Nugget Icemaker \*\*

ICE/BEV MODEL		ADAPTER #	+	SOFT ICE KIT #
ED150		02390TE	+	629088514
ED175		629087907TE	+	629088514
ED200		629083801TE	+	INCLUDED W/ ADAPTER
ED250		629083801TE	+	INCLUDED W/ ADAPTER
ED300		629087965TE	+	629088644
FlavorFusion		629097706	+	629097086
Flavor Overload		629097706	+	629097086
IDC PRO		INCLUDED	+	629097086



Ice-O-Matic **KCUBEDISP** required for CIM cube icemaker application



Ice-O-Matic **KGEMDISP** required for GEM nugget icemaker application

*Adaptors for single Ice Maker Application Only.*

## Ice Maker Adapters for Soda Dispensers

**Part # 629096784TE**  
 22" CIM Series Icemaker  
 on a 22" ED150



**Part # 629096782TE**  
 22" CIM Series Icemaker  
 on a 24.5" ED175



**Part # 02390TE**  
 21" GEM Series Icemaker  
 on a 22" ED150



**Part # 629087907TE**  
 21" GEM Series Icemaker  
 on a 24.5" ED175



**Part # 629088514**  
 21" GEM Series Icemaker  
 on a 22" ED150



Soft Ice Kit

**Part # 629088514**  
 21" GEM Series Icemaker  
 on a 24.5" ED175



Soft Ice Kit

**Part # 629096785TE**  
 22" CIM Series Icemaker  
 on a 30" ED200 / ED250



**Part # 629096792TE**  
 30" CIM Series Icemaker  
 on a 30" ED200 / ED250



**Part # 629083801TE**  
 21" GEM Series Icemaker  
 on a 30" ED200 / ED250



**Part # 02394**  
 21" GEM Series Icemaker  
 on a 30" ED200 / ED250



Soft Ice Diverter Kit

**Part # 629096786TE**  
 22" CIM Series Icemaker  
 on a 44.375" ED300



**Part # 08027TE**  
 30" CIM Series Icemaker  
 on a 44.375" ED300



**Part # 629087965TE**  
 21" GEM Series Icemaker  
 on a 44.375" ED300



**Part # 629088644**  
 21" GEM Series Icemaker  
 on a 44.375" ED300



Soft Ice Kit

IDC Ice and Beverage Combo Dispensers

IDC Pro Fast Gate



See page 2-4, 6, 9 for ice makers  
See page 37 for adapter chart



- 8" Cup Clearance.
- 120/60/1 voltage.
- Eight (8) Sanitary Lever Valves.
- 1 Variety Valve
- 12-Line Cold Plate.
- Manifold: 3-1-1-3 TotalFlex 2.
- Includes Side Splash Panels
- Ice Storage Capacity: 255 Lbs
- Has Lid and Straw holder dispensers.
- Improved Ice Portion Control System.
- LED feedback and easy entry/exit.
- Capacitive Touch Panel.

Model	Part #	Number of UFB Valves	Dispenser Type	Ice Bin Capacity (LBS)
<b>IDC255 Pro Fast Gate</b>		30" Width x 36.901" Depth x 39.75" Height		
<b>IDC255</b>	<b>621065570</b>	8	Sanitary Lever	255 lbs



*Revolutionary product selection Interface*

**IDC PRO**

*Graphical interface allows you to Tap and Scroll to make your selection. Over 3,260 drink combinations!*

Model	Part #	Number of MFV Valves	Ice Bin Capacity (LBS)
<b>IDC PRO Ice/Bev Combo with Drip Tray</b>			
<b>IDC PRO</b>	<b>621058656</b>	20 *	255 lbs

<b>IDC PRO Ice/Bev Combo without Drip Tray</b>			
<b>IDC PRO</b>	<b>621058657</b>	20 *	255 lbs

30" Width x 34.5" Depth x 39.2" Height (with drip tray)  
30" Width x 24.94" Depth x 39.2" Height (without drip tray)

- 9.75" Cup Clearance.
- 115/60/1 voltage.
- Up to 20 brands (10 each side - 7 chilled and 3 ambient) \*.
- Up to 8 flavor shots (4 per side) (Blends with drink or top-off for extra) \*.
- Dual touch screen to match dual nozzle for brand and flavoring dispense.
- Commercial-grade HD promotional 32" video merchandiser.
- ADA keypad and Integrated ice maker adaptor kit.
- Post-Mix dispenser and IDC Platform cold carb.
- On-board diagnostic service.
- Uses standard BIB syrups.



Note: Ice maker not included (sold separately)





FlavorFusion Ice and Beverage Combo Dispensers



Model                      Part #

Number of MFV Valves	Ice Bin Capacity (LBS)
----------------------	------------------------

**FlavorFusion Ice/Bev Combo with Drip Tray**

<b>FlavorFusion</b>	<b>621057644</b>	16 *	255 lbs
---------------------	------------------	------	---------

30" Width x 30" Depth x 41" Height (with drip tray)

- 10" Cup Clearance.
- 115/60/1 voltage.
- Up to 16 brands (14 chilled) and 8 FlavorShot buttons \*.
- Easily adjust flavor shot dispense times and flow rates.
- Total flexibility for carbonated and non-carbonated drinks.
- Increased drip tray capacity.
- ADA keypads on lower panel.
- Post-Mix dispenser.

Dedicated bonus (RED) flavor nozzles to add additional flavors.



ADA Keypad provides ADA compliance on 34" countertops

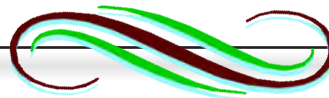

Flavor Overload Ice and Beverage Combo Dispenser



Model                      Part #

Number of MFV Valves	Ice Bin Capacity (LBS)
----------------------	------------------------

**Flavor Overload Ice/Bev Combo**

<b>Flavor Overload</b>	<b>621057636</b>	16 *	255 lbs
------------------------	------------------	------	---------

30" Width x 30" Depth x 41" Height

- 10" Cup Clearance.
- 115/60/1 voltage.
- Up to 16 brands (14 chilled) \*.
- Unlimited choices to create a personalized drink.
- Total flexibility for carbonated and non-carbonated drinks.
- Increased drip tray capacity.
- ADA keypads on lower panel.
- Post-Mix dispenser.



Note: Ice maker not included (sold separately)

See page 2-4, 6, 9 for ice makers  
See page 37 for adapter chart

Both Flavor Fusion and Overload are Midnight Black

**Ice Maker Adapter Chart for FF, FO, and IDC**

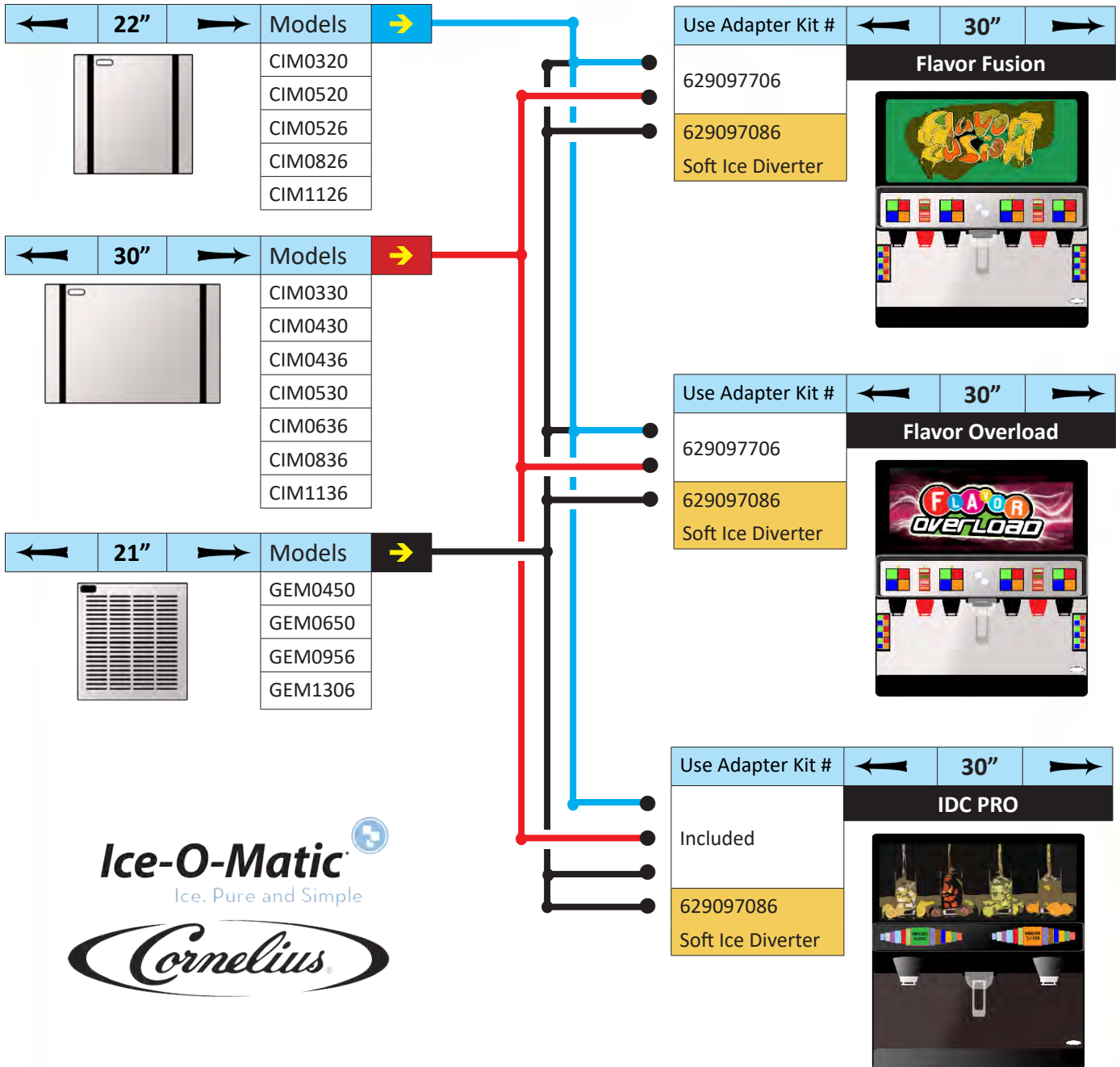

**Ice-O-Matic**  
Ice. Pure and Simple

**Cornelius**

**ICEMAKER  
ADAPTER  
DISPENSE KIT  
MATRIX**

Adaptors for single Ice Maker Application Only.

For the IDC215 or IDC255, ask a sales person for the proper adaptor kit number.

Note: Adapter kits referenced on this page are based on the Black Manual Fill Lid models.

**Cornelius**

Ice Maker Adapters for Flavor Fusion,  
Flavor Overload, and IDC Pro Dispensers

**Ice-O-Matic**  
Ice. Pure and Simple

<b>Part # 629097706</b>
22" CIM Series Icemaker
on a 30" Flavor Fusion

Universal IDC2XX

<b>Part # 629097706</b>
30" CIM Series Icemaker
on a 30" Flavor Fusion

Universal IDC2XX

<b>Part # 629097706</b>
21" GEM Series Icemaker
on a 30" Flavor Fusion

Universal IDC2XX

<b>Part # 629097086</b>
21" GEM Series Icemaker
on a 30" Flavor Fusion

Soft Ice Kit

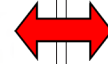

<b>Part # 629097706</b>
22" CIM Series Icemaker
on a 30" Flavor Overload

Universal IDC2XX

<b>Part # 629097706</b>
30" CIM Series Icemaker
on a 30" Flavor Overload

Universal IDC2XX

<b>Part # 629097706</b>
21" GEM Series Icemaker
on a 30" Flavor Overload

Universal IDC2XX

<b>Part # 629097086</b>
21" GEM Series Icemaker
on a 30" Flavor Overload

Soft Ice Kit

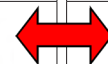

**Ice-O-Matic**  
Ice. Pure and Simple

<b>Part # 629097086</b>
21" GEM Series Icemaker
on a IDC PRO

Soft Ice Kit

# Ice Maker Adapter Kits

<p><b>Part # 629083202TE</b> 22" Manitowoc Cuber Icemaker Gray on a 22" ED150</p>	<p><b>Part # 629087002</b> 22" Hoshizaki Cuber Icemaker SS on a 22" ED150 6-Valve</p>	<p><b>Part # 08008TE</b> 22" Cuber Icemaker Gray on a 22" ED150</p>
		
<p><b>Part # 629087959</b> 22" Hoshizaki Cuber Icemaker Black on a 22" ED150</p>	<p><b>Part # 02388TE</b> 22" Scotsman Cuber Icemaker 22" I-Series Cuber Icemaker on a 22" DF150</p>	<p><b>Part # 629087906TE</b> 22" Cuber Icemaker Gray on a 24.5" ED175</p>
		
<p><b>Part # 629087907TE</b> 22" GEM Series Icemaker Black on a 24.5" ED175</p>	<p><b>Part # 629087908</b> 22" Hoshizaki Cuber Icemaker Black on a 24.5" ED175</p>	<p><b>Part # 629096786TE</b> 22" Cuber Icemaker, Black on a 44.375" ED300</p>
		

Note: The adapter kits referenced above are a mixed assembly.

# Ice Maker Adapter Kits

<p><b>Part # 08010TE</b>  <b>30" Cuber Icemaker</b>  <b>Gray</b>  <b>on a 30" ED200 / ED250</b></p> 	<p><b>Part # 08055TE</b>  <b>22" Cuber Icemaker</b>  <b>Gray</b>  <b>on a 30" ED200 / ED250</b></p> 	<p><b>Part # 629083801TE</b>  <b>14" WCC Nugget Icemaker</b>  <b>Black</b>  <b>on a 30" ED200 / ED250</b></p> 
<p><b>Part # 629083802TE</b>  <b>14" WCC500/700 Icemaker</b>  <b>Gray</b>  <b>on a 30" ED200 / ED250</b></p> 	<p><b>Part # 629087001</b>  <b>22" Hoshizaki Cuber Icemaker</b>  <b>30" Hoshizaki Cuber Icemaker</b>  <b>on a 30" DF/ED200 - DF/ED250</b></p> 	<p><b>Part # 629096791TE</b>  <b>22" CIM or CNM Icemaker</b>  <b>Gray</b>  <b>on a 30" ED200 / ED250</b></p> 
<p><b>Part # 08006TE</b>  <b>30" Cuber Icemaker, Black</b>  <b>Black</b>  <b>on a 30" ED200 / ED250</b></p> 	<p><b>Part # 629087572</b>  <b>Scotsman Eclipse Icemaker</b>  <b>Gray</b>  <b>on a 30" DF/ED200 - DF/ED250</b></p> 	<p><b>Part # 629083103TE</b>  <b>30" Cuber Icemaker</b>  <b>Gray</b>  <b>on a 30" DF200 / DF250</b></p> 

Note: The adapter kits referenced above are a mixed assembly.

Carbonators

Part # Description

**Big Mac Carbonator**

**E400397** Big Mac Carbonator with ASSE 1022 Device

**BIG MAC**

14" Width x 13" Depth x 10.5" Height

- Two-piece probe design.
- 115v, 60hz, 7amp, 1/3hp.
- Right angle probe service cord.
- Brass water pump w/ integral strainer.
- 1/4" MF CO2 inlet, (2) 3/8" MF soda water outlets.
- Diamond Brite Tank, easy clean, reduces corrosion.



E400397

Note: 5-year component warranty on two-piece probe and carbonator tank.

Part # Description

**Carb-In-A-Box Carbonator**

**416411000** VA Balance Control Carbonator

**VA BALANCE CONTROL**

6.25" Width x 14" Depth x 15.125" Height



416411000

- Rubber feet for stability and quiet.
- 115v, 60hz, 6.8 amp, 1/3hp.
- Brass water pump w/ integral strainer.
- 1/4" MF CO2 inlet, 3/8" MF water inlet.
- 1/4" MF on carbonated water outlet.
- Designed to allow mounting to wall surface.
- 100 gpm water pump capacity.



Part # Description

**Small Carbonator**

**43-6002** Small Carbonator with ASSE 1022 Device

**Small Carb**

9" Width x 11.5" Depth x 11" Height

- Two-piece probe design.
- 115v, 60hz, 7amp, 1/3hp.
- Right angle probe service cord.
- Brass water pump w/ integral strainer.
- 1/4" MF CO2 inlet, 3/8" MF water inlet.
- 3/8" MF soda water outlet.

Note: 5-year component warranty on two-piece probe and carbonator tank.



Accessories and Cold Plates

ASSE 1022: It's a back-flow prevention device that provides pressure relief in the event that the primary check valve fails. It ensures that the secondary check valve remains closed.

*A carbonator facilitates the combining of water and CO2 gas that puts the fizz to soda.*

**Item # 16-0856**

Pump saver, auto-shut off on carb motor when water pressure drops below 15-psi

Stocked



**Item # 16-1480**

Wall mount space-saver carbonator shelf for use with 43-6002 carbonator

Stocked



FOR MCCANN: E400397 - BIG MAC

FOR MCCANN: 43-6002 - Carbonator

Is the cost of equipment, accessories, and parts weighing you down?

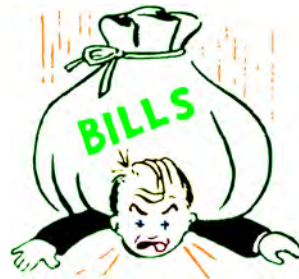

Buy from us!

**Cold Plate 8" x 14", Post-Mix**

GIS Part #	Description	
77-5110-01-FI	8" x 14", 7 circuits, 1/4" tube size, post-mix	N/S



**Cold Plate 10" x 15", Post-Mix**

GIS Part #	Description	
77-5117-01-FI	10" x 15", 6 circuits, 5/16" tube size, post-mix	Stocked



77-5110-01-FI



77-5117-01-FI

Other cold plate configurations are available.

N/S = Non-Stocked Item, requires special order and lead time.

Ice

# Water Filtration



**Everpure Insurice Filtration Systems:**

- Reduces abrasion and clogging.
- Reduces scale build-up and corrosion.
- Reduces off-tastes and odors.
- Reduces harmful cysts and other contaminants.
- Reduces particulates that result in cloudy ice.
- **Remember:** It's suggested to replace filter cartridges every 6-months.



<b>EV9324-01</b>
<b>Insurice Single i2000 System</b>
Max Flow Rate: 1.67 gpm
Use this system with ice maker rated
Max Cuber Size: Up to 750 lbs / day
Max Flaker Size: Up to 1500 lbs / day
<b>GIS # 9324-01</b>



<b>EV9324-02</b>
<b>Insurice Twin i2000 System</b>
Max Flow Rate: 3.34 gpm
Use this system with ice maker rated
Max Cuber Size: Up to 1450 lbs / day
Max Flaker Size: Up to 2200 lbs / day
<b>GIS # 9324-02</b>



<b>EV9325-03</b>
<b>Insurice Triple i4000 System</b>
Max Flow Rate: 5 gpm
Use this system with ice maker rated
Max Cuber Size: Up to 2400 lbs / day
Max Flaker Size: Up to 3500 lbs / day
<b>GIS # 9325-03</b>



<b>EV9325-04</b>
<b>Insurice Quad i4000 System</b>
Max Flow Rate: 6.7 gpm
Use this system with ice maker rated
Max Cuber Size: High volume / day
Max Flaker Size: High volume / day
<b>GIS # 9325-04</b>

**Insurice i2000 Replacement Cartridge**

Fits Single and Twin Systems

**EV9612-27**

20.75" Height

**GIS # 9612-27**



**Insurice i4000 Replacement Cartridge**

Fits Triple and Quad Systems

**EV9612-37**

25" Height

**GIS # 9612-37**



**Insurice Filter Systems with Pre-Filter**

Item #	Description	
EV9324-21	Insurice Single PF-i2000 System with Pre-Filter	--
EV9324-22	Insurice Twin PF-i2000 System with Pre-Filter	--
EV9325-23	Insurice Triple PF-i4000 System with Pre-Filter	--



Select the Insurice system with pre-filter when larger dirt and rust particles are a factor. It will extend the life of the primary filter cartridges.

**\*\* VOLUME PRICING AVAILABLE \*\***



# Water Filtration



## Ice-O-Matic 3-in-1 Filtration Systems:

- Protection against sediment.
- Protection against unpleasant tastes & odors.
- Protection against scale formation.
- *Remember:* It's suggested to replace filter cartridges every 6-months.

**Ice-O-Matic**  
Ice. Pure and Simple



<b>IFQ1-S</b>
<b>3-in-1 Single System</b>
Service Flow Rate: .75 gpm
6" W x 4" D x 10.4" H
Use this system with ice maker rated
Max Cuber Size: Up to 700 lbs / day
Max Flaker Size: Up to 700 lbs / day

> Wall-mount bracket and full-flow inlet shut-off valve make installation simple.



<b>IFQ1</b>
<b>3-in-1 Single System</b>
Service Flow Rate: 1.5 gpm
6" W x 4" D x 15" H
Use this system with ice maker rated
Max Cuber Size: Up to 1000 lbs / day
Max Flaker Size: Up to 1000 lbs / day

> Wall-mount bracket and full-flow inlet shut-off valve make installation simple.



<b>IFQ1-XL</b>
<b>3-in-1 Single System</b>
Service Flow Rate: 2.25 gpm
6" W x 4" D x 21" H
Use this system with ice maker rated
Max Cuber Size: Up to 1000 lbs / day
Max Flaker Size: Up to 1000 lbs / day

> Wall-mount bracket and full-flow inlet shut-off valve make installation simple.

### IFQ System Replacement Cartridge

Fits IFQ Single and Twin Systems

<b>IOMQ-S</b>	10.4" Height
---------------	--------------

> 1/4 turn QT "QuickTwist" cartridge makes changing the filter quick, easy and sanitary.  
> .5 micron filtration.



### IFQ System Replacement Cartridge

Fits IFQ Single and Twin Systems

<b>IOMQ</b>	12.75" Height
-------------	---------------

> 1/4 turn QT "QuickTwist" cartridge makes changing the filter quick, easy and sanitary.  
> .5 micron filtration.



### IFQ-XL System Replacement Cartridge

Fits IFQ1-XL Single and Twin Systems

<b>IOMQ-XL</b>	17.49" Height
----------------	---------------

> 1/4 turn QT "QuickTwist" cartridge makes changing the filter quick, easy and sanitary.  
> .5 micron filtration.



# Water Filtration



## Ice-O-Matic 3-in-1 Filtration Systems:

- Protection against sediment.
- Protection against unpleasant tastes & odors.
- Protection against scale formation.
- **Remember:** It's suggested to replace filter cartridges every 6-months.

**Ice-O-Matic**  
Ice. Pure and Simple



<b>IFQ2</b>
<b>3-in-1 Twin System</b>
Service Flow Rate: 3.0 gpm
10" W x 7.125" D x 16" H
Use this system with ice maker rated
Max Cuber Size: Up to 2400 lbs / day
Max Flaker Size: Up to 2400 lbs / day

> Wall-mount bracket and full-flow inlet shut-off valve make installation simple.

<b>IFQ System Replacement Cartridge</b>	
Fits IFQ Single and Twin Systems	
<b>IOMQ</b>	12.75" Height

> 1/4 turn QT "QuickTwist" cartridge makes changing the filter quick, easy and sanitary.  
> .5 micron filtration.



<b>IFQ2-XL</b>
<b>3-in-1 Twin System</b>
Service Flow Rate: 4.5 gpm
10" W x 7.125" D x 23.21" H
Use this system with ice maker rated
Max Cuber Size: Up to 2400 lbs / day
Max Flaker Size: Up to 2400 lbs / day

> Wall-mount bracket and full-flow inlet shut-off valve make installation simple.

<b>IFQ-XL System Replacement Cartridge</b>	
Fits IFQ1-XL Single and Twin Systems	
<b>IOMQ-XL</b>	17.49" Height

> 1/4 turn QT "QuickTwist" cartridge makes changing the filter quick, easy and sanitary.  
> .5 micron filtration.



## In-Line Water Filtration System

Part #	Description
IFI4C	Single In-Line Cartridge, 1/4" Compression
IFI8C	Single In-Line Cartridge, 1/8" Compression

For use with ICEU070, ICEU150, ICEU220, ICEU300, ALL UCGXXX and MFI0500.



IFI4C



IFI8C

Note: Ice-O-Matic offers an extended 7-year parts and labor evaporator warranty (on specific models) **IF** the customer enrolls in their 3-in-1 filter replacement program at the time a new ice machine is purchased. Due to the extensive requirements for the filter cartridge to be changed every 6-months, please ask a salesperson for details of the program before committing to it.

Colddrink Systems without Pre-Filter

# Water Filtration



Everpure MC2 Filtration Systems:

- Reduces abrasion and clogging.
- Reduces improper carbonation.
- Reduces off-tastes and odors.
- Reduces harmful cysts and other contaminates.
- For use with carbonated beverage systems only.
- *Remember:* It's suggested to replace filter cartridges every 6-months.



<b>EV9275-01</b>
<b>QC7I Single-MC2</b>
Max Flow Rate: 1.67 gpm
<u>System Information</u>
# of Carbonators: 1
# of Bag-In-Box: <25 / month
<b>Rated Capacity: 9,000 gallons</b>
--



<b>EV9275-02</b>
<b>QC7I Twin-MC2</b>
Max Flow Rate: 3.34 gpm
<u>System Information</u>
# of Carbonators: 2
# of Bag-In-Box: <50 / month
<b>Rated Capacity: 18,000 gallons</b>
<b>GIS # 9275-02</b>



<b>EV9275-03</b>
<b>QC7I Triple-MC2</b>
Max Flow Rate: 5 gpm
<u>System Information</u>
# of Carbonators: 3
# of Bag-In-Box: <75 / month
<b>Rated Capacity: 27,000 gallons</b>
<b>GIS # 9275-03</b>

Select a system without a pre-filter when larger dirt and rust particles are not a factor.



**Fountain Beverages  
are  
83% water**



<b>EV9336-11 (Head) and EV9612-56 (x4 Cartridges)</b>
<b>Colddrink Quad-MC2</b>
Max Flow Rate: 6.68 gpm
<u>System Information</u>
# of Carbonators: 4
# of Bag-In-Box: >75 / month
<b>System built using (1) head and (4) filters</b>
<b>GIS # 9336-11 and GIS # 9612-55</b>

<b>MC2 Replacement Cartridge</b>	
Fits Single, Twin, and Triple Systems	
<b>EV9612-55</b>	20.75" Height
<b>GIS # 9612-55</b>	



Colddrink Systems with Pre-Filter

# Water Filtration

## EVERPURE



**Everpure MC2 Filtration Systems:**

- Reduces abrasion and clogging.
- Reduces improper carbonation.
- Reduces off-tastes and odors.
- Reduces harmful cysts and other contaminates.
- For use with carbonated beverage systems only.
- *Remember:* It's suggested to replace filter cartridges every 6-months.



<b>EV9328-01</b>
<b>Coldrink 1-MC2 w/ Pre-Filter</b>
Max Flow Rate: 1.67 gpm
<u>System Information</u>
# of Carbonators: 1
# of Bag-In-Box: <25 / month
<b>Rated Capacity: 9,000 gallons</b>
<b>GIS # 9328-01</b>



<b>EV9328-02</b>
<b>Coldrink 2-MC2 w/ Pre-Filter</b>
Max Flow Rate: 3.34 gpm
<u>System Information</u>
# of Carbonators: 2
# of Bag-In-Box: <50 / month
<b>Rated Capacity: 18,000 gallons</b>
<b>GIS # 9328-02</b>



<b>EV9328-03</b>
<b>Coldrink 3-MC2 w/ Pre-Filter</b>
Max Flow Rate: 5 gpm
<u>System Information</u>
# of Carbonators: 3
# of Bag-In-Box: <75 / month
<b>Rated Capacity: 27,000 gallons</b>
<b>GIS # 9328-03</b>

<b>MC2 Replacement Cartridge</b>
Fits Single, Twin, and Triple Systems
<b>EV9612-55</b> 20.75" Height
<b>GIS # 9612-55</b>



<b>EC210 Pre-Filter Replacement Cartridge</b>
Fits systems using the E20 housing
<b>EV9534-20</b> 20" Height
<b>GIS # 9534-20</b>



**Fountain Beverages  
are  
83% water**

Systems with prefilters extend the life of the primary filter cartridges.

Colddrink FC Systems with Pre-Filter



Everpure FC Filtration Systems:

- Reduces chlorine taste and odor.
- Inhibits bacteria growth.
- Reduces chemical and mechanical contaminants.
- For use with carbonated beverage systems.
- *Remember: It's suggested to replace filter cartridges every 6-months.*

# Water Filtration



<b>EV9328-44</b>
<b>Coldrink 4-4FC</b>
Max Flow Rate: 10 gpm
Rated Capacity: 60,000 gallons
<b>N/S</b>

<b>4FC Replacement Cartridge</b>
Fits Coldrink 4-4FC Quad System
<b>EV9692-21</b> 14.5" Height
GIS # 9692-21

High Capacity Fibredyne



<b>EV9328-73</b>
<b>Coldrink 3-7FC</b>
Max Flow Rate: 7.5 gpm
Rated Capacity: 75,000 gallons
<b>N/S</b>

<b>7FC Replacement Cartridge</b>
Fits 7FC Triple and quad Systems
<b>EV9692-61</b> 20.75" Height
GIS # 9692-61

High Capacity Fibredyne



<b>EV9328-74</b>
<b>Coldrink 4-7FC</b>
Max Flow Rate: 10 gpm
Rated Capacity: 100,000 gallons
<b>N/S</b>

<b>EC210 Pre-Filter Replacement Cartridge</b>
Fits systems using the E20 housing
<b>EV9534-20</b> 20" Height
GIS # 9534-20



N/S = Non-Stocked Item, requires special order and lead time.

<b>EC110 Pre-Filter Replacement Cartridge</b>
Fits systems using the E10 housing
<b>EV9534-40</b> 10" Height
GIS # 9534-40



Systems with prefilters extend the life of the primary filter cartridges.

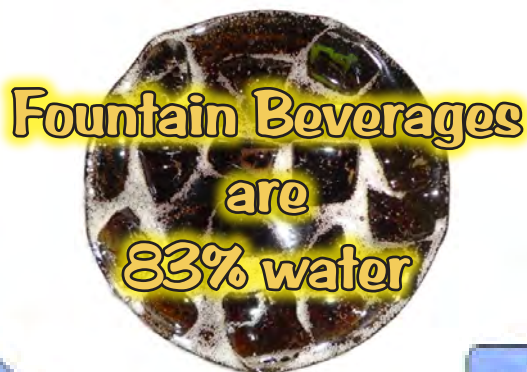

7CLM+ Colddrink Systems

# Water Filtration



Everpure 7CLM+ Filtration Systems:

- Reduces abrasion and clogging.
- Reduces improper carbonation.
- Reduces off-tastes and odors.
- Reduces harmful cysts and other contaminants.
- **High capacity Chloramines reduction.**
- For fountain beverage, frozen carbinated beverage, and drinking water applications.
- NSF 42 certification.
- *Remember:* It's suggested to replace filter cartridges every 6-months.

7CLM Replacement Cartridge

EV9771-00

GIS # EV977100



EV9771-11



EV9771-12



EV9771-13



EV9771-14

Vendor #	System Description	Flow Rate (gpm)	Rated Capacity (gallons)	SYSTEM #
EV9771-11	QC7I Single-7CLM+	1.67	7,500	GIS # EV977111
EV9771-12	QC7I Twin-7CLM+	3.34	15,000	--
EV9771-13	QC7I Triple-7CLM+	5.01	22,500	N/S
EV9771-14	QC7I Quad-7CLM+	6.68	30,000	N/S

N/S = Non-Stocked Item, requires special order and lead time.



EV9771-21



EV9771-22



EV9771-23



EV9771-24

← with Pre-Filter

Vendor #	System Description	Flow Rate (gpm)	Rated Capacity (gallons)	SYSTEM #
EV9771-21	Colddrink 1-7CLM+	1.67	7,500	N/S
EV9771-22	Colddrink 2-7CLM+	3.34	15,000	--
EV9771-23	Colddrink 3-7CLM+	5.01	22,500	N/S
EV9771-24	Colddrink 4-7CLM+	6.68	30,000	N/S

N/S = Non-Stocked Item, requires special order and lead time.

EC210 Pre-Filter Cartridge

EV9534-20

GIS # 9534-20



XCLM+ Colddrink Systems



**Everpure XCLM+ Filtration Systems:**

- Reduces abrasion and clogging.
- Reduces improper carbonation.
- Reduces off-tastes and odors.
- Reduces harmful cysts and other contaminates.

# Water Filtration



- **Extra high capacity Chloramines reduction.**
- For fountain beverage, frozen carbonated beverage, and drinking water applications.
- NSF 42 certification.
- *Remember:* It's suggested to replace filter cartridges every 6-months.



**XCLM Replacement Cartridge**

**EV9761-00**

GIS # EV976100



EV9761-11

EV9761-12

EV9761-13

EV9761-14

Vendor #	System Description	Flow Rate (gpm)	Rated Capacity (gallons)	SYSTEM #
<b>EV9761-11</b>	QC7I Single-XCLM+	2.00	9,300	<b>GIS # EV976111</b>
<b>EV9761-12</b>	QC7I Twin-XCLM+	4.00	18,600	<b>N/S</b>
<b>EV9761-13</b>	QC7I Triple-XCLM+	6.00	27,900	<b>N/S</b>
<b>EV9761-14</b>	QC7I Quad-XCLM+	8.00	37,200	<b>N/S</b>

N/S = Non-Stocked Item, requires special order and lead time.



← with Pre-Filter

EV9761-21

EV9761-22

EV9761-23

EV9761-24

**EC210 Pre-Filter Cartridge**

**EV9534-20**

GIS # 9534-20



Vendor #	System Description	Flow Rate (gpm)	Rated Capacity (gallons)	
<b>EV9761-21</b>	Colddrink 1-XCLM+	2.00	9,300	<b>N/S</b>
<b>EV9761-22</b>	Colddrink 2-XCLM+	4.00	18,600	<b>N/S</b>
<b>EV9761-23</b>	Colddrink 3-XCLM+	6.00	27,900	<b>N/S</b>
<b>EV9761-24</b>	Colddrink 4-XCLM+	8.00	37,200	<b>N/S</b>

N/S = Non-Stocked Item, requires special order and lead time.

# Water Filtration



**Everpure High Capacity Filtration Systems:**

- Reduces abrasion and clogging.
- Reduces improper carbonation.
- Reduces off-tastes and odors.
- Reduces harmful cysts and other contaminants.
- 1/2 micron precoat filtration with MicroPure II media.
- Systems come with SR-X Scale Feeder.
- Systems come with 20" coarse pre-filter.
- Manifold has inlet shut-off valve, flushing valve, water pressure gauges, and dual outlets.
- *Remember:* It's suggested to replace filter cartridges every 6-months.



<b>EV9330-42</b>
<b>High Flow CSR Twin-MC2</b>
Max Flow Rate: 3.34 gpm
<u>System Information</u>
# of Carbonators: 1
# of Coffee Brewers: 2
Ice Machine: Up to 600 lbs
<b>Rated Capacity: 18,000 gallons</b>
<b>GIS # 9330-42</b>



<b>EV9328-06</b>
<b>High Flow CSR Triple-MC2</b>
Max Flow Rate: 5 gpm
<u>System Information</u>
# of Carbonators: 2
# of Coffee Brewers: 4
Ice Machine: Up to 600 lbs
<b>Rated Capacity: 27,000 gallons</b>
<b>GIS # 9328-06</b>



<b>EV9437-10</b>
<b>High Flow CSR Quad-MC2</b>
Max Flow Rate: 6.70 gpm
<u>System Information</u>
# of Carbonators: 3
# of Coffee Brewers: 4
Ice Machine: Up to 1200 lbs
<b>Rated Capacity: 36,000 gallons</b>
<b>GIS # 9437-10</b>

<b>MC2 Cartridge</b>
<b>EV9612-55</b>
<b>GIS # 9612-55</b>



<b>EC210 Pre-Filter</b>
<b>EV9534-20</b>
<b>GIS # 9534-20</b>



<b>SS-IMF ScaleStick</b>
<b>EV9799-32</b>
<b>GIS # 9799-32</b>



<b>SS-XL ScaleStick</b>
<b>EV9799-42</b>
<b>GIS # 9799-42</b>



<b>EV9328-05</b>
<b>High Flow CSR Triple-MC2 with Low Pressure Alarm</b>
<u>Same specifications as EV9328-06</u>
<b>GIS # 9328-05</b>



# Water Filtration



## Everpure High Capacity Filtration Systems:

- Reduces abrasion and clogging.
- Reduces improper carbonation.
- Reduces off-tastes and odors.
- Reduces harmful cysts and other contaminants.
- 1/2 micron precoat filtration.
- Systems come with SR-X Scale Feeder.
- Systems come with 20" coarse pre-filter (EV9329-44 comes with 10" pre-filter).
- Manifold has inlet shut-off valve, flushing valve, water pressure gauges, and dual outlets.
- *Remember:* It's suggested to replace filter cartridges every 6-months.



<b>EV9329-73</b>
<b>High Flow CSR Triple-7FC</b>
Max Flow Rate: 7.50 gpm
Rated Capacity: 75,000 gallons
<b>N/S</b>



<b>EV9329-44</b>
<b>High Flow CSR Quad-4FC</b>
Max Flow Rate: 10 gpm
Rated Capacity: 60,000 gallons
<b>N/S</b>



<b>EV9329-74</b>
<b>High Flow CSR Quad-7FC</b>
Max Flow Rate: 10 gpm
Rated Capacity: 100,000 gallons
<b>GIS # 9329-74</b>

### 4FC Cartridge

<b>EV9692-21</b>
<b>GIS # 9692-21</b>



### 7FC Cartridge

<b>EV9692-61</b>
<b>GIS # 9692-61</b>



High Capacity Fibredyne

### EC110 Pre-Filter

<b>EV9534-40</b>
<b>GIS # 9534-40</b>



### EC210 Pre-Filter

<b>EV9534-20</b>
<b>GIS # 9534-20</b>



### SS-IMF ScaleStick

<b>EV9799-32</b>
<b>GIS # 9799-32</b>



### SS-XL ScaleStick

<b>EV9799-42</b>
<b>GIS # 9799-42</b>



N/S = Non-Stocked Item, requires special order and lead time.

NOTE: Systems are also available with low pressure alarm, indicating when a filter has become plugged. If a filter system listed above requires an LP alarm, ask a GIS salesperson for a vendor number and price.

High Flow CSR CLM+ Systems

# Water Filtration



Everpure HF CSR CLM+ Filtration Systems:

- Reduces abrasion and clogging.
- Reduces improper carbonation.
- Reduces off-tastes and odors.
- Reduces harmful cysts and other contaminants.
- **High capacity Chloramines reduction.**
- For fountain beverage, frozen carbinated beverage, and drinking water applications.
- NSF 42 certification.
- *Remember: It's suggested to replace filter cartridges every 6-months.*



EV9771-32



EV9771-33



EV9771-34

**7CLM+ Cartridge**  
**EV9771-00**  
 GIS # EV977100



Vendor #	System Description	Flow Rate (gpm)	Rated Capacity (gallons)	
<b>EV9771-32</b>	<b>High Flow CSR Twin-7CLM+</b>	3.34	15,000	--
<b>EV9771-33</b>	<b>High Flow CSR Triple-7CLM+</b>	5.01	22,500	--
<b>EV9771-34</b>	<b>High Flow CSR Quad-7CLM+</b>	6.68	30,000	--

**XCLM+ Cartridge**  
**EV9761-00**  
 GIS # EV976100



EV9771-21



EV9771-22



EV9771-23

**EC210 Pre-Filter**  
**EV9534-20**  
 GIS # 9534-20



Vendor #	System Description	Flow Rate (gpm)	Rated Capacity (gallons)	
<b>EV9761-32</b>	<b>High Flow CSR Twin-XCLM+</b>	4.00	18,600	N/S
<b>EV9761-33</b>	<b>High Flow CSR Triple-XCLM+</b>	6.00	27,900	N/S
<b>EV9761-34</b>	<b>High Flow CSR Quad-XCLM+</b>	8.00	37,200	N/S

**SS-IMF ScaleStick**  
**EV9799-32**  
 GIS # 9799-32



N/S = Non-Stocked Item, requires special order and lead time.

Endurance High Flow Systems

# Water Filtration

## EVERPURE



Everpure High Flow Filtration Systems:

- Meets peak water demands.
- Mechanical particulate reduction system.
- Reduces off-tastes and odors.
- Superior contaminant reduction.
- 1/2 micron precoat filtration.
- Incorporates 2SR-BW phosphate cartridge for scale prevention.
- Systems have outstanding dirt-capturing capabilities.
- High capacity allows for once-per-year filter changeouts.

<b>EV9437-30</b>
<b>Endurance Twin High Flow</b>
Max Flow Rate: 7.50 gpm
Rated Capacity: 100,000 gallons

N/S

<b>EV9437-31</b>
<b>Endurance Triple High Flow</b>
Max Flow Rate: 11.25 gpm
Rated Capacity: 150,000 gallons

--

<b>EV9437-32</b>
<b>Endurance Quad High Flow</b>
Max Flow Rate: 15.00 gpm
Rated Capacity: 200,000 gallons

--

<b>Twin Cartridge Kit</b>
For EV9437-30 Endurance
<b>EV9628-70</b>
N/S



<b>Triple Cartridge Kit</b>
For EV9437-31 Endurance
<b>EV9628-71</b>
--



<b>Quad Cartridge Kit</b>
For EV9437-32 Endurance
<b>EV9628-72</b>
--



N/S = Non-Stocked Item, requires special order and lead time.

For Coffee / Tea Brewer Systems



Everpure Coffee / Tea Filtration Systems:

- Reduces abrasion and clogging.
- Reduces scale build-up and corrosion.
- Reduces off-tastes and odors.
- Reduces harmful cysts and other contaminants.
- For use with coffee or related systems only.
- **Remember:** It's suggested to replace filter cartridges every 6-months.

# Water Filtration

## EVERPURE®



<b>EV9275-60</b>
<b>QL2-OCS2 Single System</b>
Flow Rate: .5 gpm
<u>System Information</u>
Equipment Type: 1-3 Pot Brewers
# of 1/2 gallon pots: 3000
# of gallon pots: 1500
<b>Rated Capacity: 1500 gallons</b>
<b>GIS # 9275-60</b>



<b>EV9272-00</b>
<b>QL3-BH2 Single System</b>
Flow Rate: .5 gpm
<u>System Information</u>
Equipment Type: 1-3 Pot Brewers
# of 1/2 gallon pots: 6000
# of gallon pots: 3000
<b>Rated Capacity: 3000 gallons</b>
<b>GIS # 9272-00</b>



<b>Head: EV9272-41</b>	<b>Cartridge: EV9613-26</b>
<b>QC7I Single-MH2 Head and MH2 Filter Cartridge</b>	
Flow Rate: 1 gpm	
<u>System Information</u>	
Equipment Type: 5 Pot Brewers and satellite system	
# of 1/2 gallon pots: 18000	
# of gallon pots: 9000	
<b>Rated Capacity: 9000 gallons</b>	
<b>GIS # 9272-41 and GIS # 9613-06</b>	



EV9618-07  
OCS2  
10.25" High



EV9612-51  
BH2  
14.5" High



EV9613-26  
MH2  
20.75" High

Filtration Replacement Cartridges

Item #	Description	
EV9618-07	OCS2 Cartridge	<b>GIS # 9618-07</b>
EV9612-51	BH2 Cartridge	<b>GIS # 9612-01</b>
EV9613-26	MH2 Cartridge	<b>GIS # 9613-06</b>

For use with the identified Coffee Filtrations Systems



<b>Head: EV9272-22</b>	<b>Cartridge: EV9613-26 (x 2)</b>
<b>QC7I Twin-MH2 Head and (x2) MH2 Filter Cartridges</b>	
Flow Rate: 1 gpm	
<u>System Information</u>	
Equipment Type: 5 -15 gallon urns	
# of 1/2 gallon pots: N/A	
# of gallon pots: 18000	
<b>Rated Capacity: 18000 gallons</b>	
<b>GIS # 9272-22 and GIS # 9613-06</b>	

\* Head and cartridges sold separately (Purchase to make complete system)

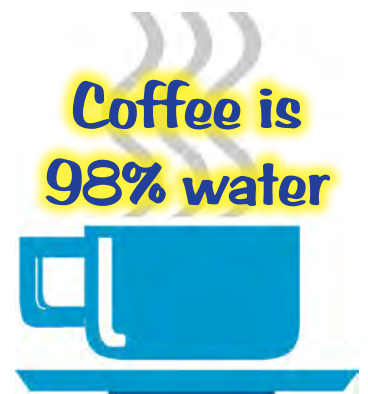

# Water Filtration

## EVERPURE®



EV9256-18



EV9272-18

← None of these heads have a flushing valve or pressure gauge(s).

Product	Vendor #	Shut-Off Valve	Mounting Bracket	Connection	SYSTEM #
QL1 Single Head	EV9256-18	N	Y	3/8" NPT	GIS # 9256-18
QL2 Single Head	EV9272-18	N	Y	3/8" NPT	GIS # 9272-18



EV9272-41



EV9272-22



EV9272-23



EV9336-11

Product	Vendor #	Shut-Off Valve	Mounting Bracket	Connection	SYSTEM #
QC71 / Insurice Single Head	EV9272-41	Y	Y	3/8" NPT	GIS # 9272-41
QC71 / Insurice Twin Parallel Head	EV9272-22	Y	Y	3/4" NPT	GIS # 9272-22
QC71 / Insurice Triple Parallel Head	EV9272-23	Y	Y	3/4" NPT	GIS # 9272-23
QC71 / Insurice Quad Parallel Head	EV9336-11	Y	Y	3/4" NPT	GIS # 9336-11

These heads have a flushing valve and pressure gauge(s).

Parallel Head Description: Flow rate and capacities of all cartridges are combined to determine total system flow rate and capacity. Inlet water passes through all filter cartridges simultaneously.



Filter Replacement Cartridges



**Remember:  
Replace Filter Cartridges  
Every 6 Months**



*Filter Replacement Cartridges*

Application	Vendor #	Cartridge ID	Micron Rating	Flow Rate (gpm)	Rated Capacity (gallons)		SYSTEM #
Fountain or Combination	<b>EV9618-16</b>	7CB5	5.0	2.50	10,000	Carbon Block Filter	<b>GIS # 9618-16</b>
	<b>EV9693-21</b>	4FC5	5.0	2.50	15,000	High Capacity Fibredyne	<b>N/S</b>
	<b>EV9693-61</b>	7FC5	5.0	2.50	25,000	High Capacity Fibredyne	<b>N/S</b>
	<b>EV9612-55</b>	MC2	0.5	1.67	9,000	Precoat Fine Filter	<b>GIS # 9612-55</b>
	<b>EV9613-97</b>	XC2	0.5	1.67	12,000	Precoat Fine Filter	<b>GIS # 9613-96</b>
	<b>EV9692-21</b>	4FC	0.5	2.50	15,000	High Capacity Fibredyne	<b>GIS # 9692-21</b>
	<b>EV9692-61</b>	7FC	0.5	2.50	25,000	High Capacity Fibredyne	<b>GIS # 9692-61</b>
	<b>EV9693-10</b>	4FC-L	0.5	1.80	4,900	Lead Reduction Filter	<b>N/S</b>
	<b>EV9693-40</b>	7FC-L	0.5	2.70	7,400	Lead Reduction Filter	<b>N/S</b>
	<b>EV9771-00</b>	7CLM+	5.0	1.67	7,500	Chloramine Reduction	<b>GIS # EV977100</b>
	<b>EV9761-00</b>	XCLM+	5.0	2.00	9,300	Chloramine Reduction	<b>GIS # EV976100</b>
Ice	<b>EV9618-21</b>	7CB5-S	5.0	2.50	10,000	Carbon Block Filter	<b>GIS # 9618-21</b>
	<b>EV9693-31</b>	4FC5-S	5.0	2.50	15,000	High Capacity Fibredyne	<b>GIS # EV9693-31</b>
	<b>EV9693-71</b>	7FC5-S	5.0	2.50	25,000	High Capacity Fibredyne	<b>N/S</b>
	<b>EV9612-27</b>	i2000(2)	0.5	1.67	9,000	Precoat Fine Filter	<b>GIS # 9612-27</b>
	<b>EV9612-37</b>	i4000(2)	0.5	1.67	12,000	Precoat Fine Filter	<b>GIS # 9612-37</b>
	<b>EV9692-31</b>	4FC-S	0.5	2.50	15,000	High Capacity Fibredyne	<b>GIS # 9692-31</b>
	<b>EV9692-71</b>	7FC-S	0.5	2.50	25,000	High Capacity Fibredyne	<b>N/S</b>
	<b>EV9693-16</b>	4FC-LS	0.5	1.80	4,900	Lead Reduction Filter	<b>N/S</b>
	<b>EV9693-46</b>	7FC-LS	0.5	2.70	7,400	Lead Reduction Filter	<b>N/S</b>
	<b>EV9606-51</b>	4SI	0.5	2.00	15,000	Antibacteria-Slime Filter	<b>N/S</b>
	<b>EV9606-01</b>	7SI	0.5	3.50	25,000	Antibacteria-Slime Filter	<b>GIS # EV9606-01</b>
Coffee	<b>EV9617-22</b>	2CB5-S	5.0	1.00	3,000	Carbon Block Filter	<b>GIS # 9617-22</b>
	<b>EV9617-26</b>	4CB5-S	5.0	1.67	6,000	Carbon Block Filter	<b>GIS # 9617-21</b>
	<b>EV9618-21</b>	7CB5-S	5.0	2.50	10,000	Carbon Block Filter	<b>GIS # 9618-21</b>
	<b>EV9618-07</b>	OCS2	0.5	0.50	1,500	Precoat Fine Filter	<b>GIS # 9618-07</b>
	<b>EV9612-51</b>	BH2	0.5	0.50	3,000	Precoat Fine Filter	<b>GIS # 9612-01</b>
	<b>EV9613-26</b>	MH2	0.5	1.67	9,000	Precoat Fine Filter	<b>GIS # 9613-06</b>

N/S = Non-Stocked Item, requires special order and lead time.

Filter Replacement Cartridges

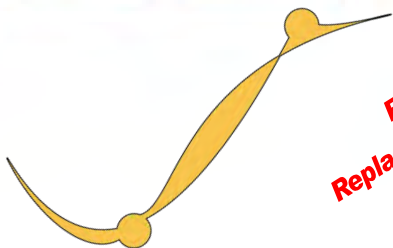

**Remember:  
Replace Filter Cartridges  
Every 6 Months**

# Water Filtration



## Specialty Cartridges

Vendor #	Cartridge ID	Flow Rate (gpm)	Rated Capacity (gallons)	Technology	SYSTEM #
<i>PROBLEM: → Extraordinary Taste &amp; Odor, High Turbidity</i>					
<b>EV9607-56</b>	<b>7TO</b>	1.50	30,000	Granular Activated Carbon	<b>GIS # 9607-56</b>
<i>PROBLEM: → High Mineral Content (Low volume application)</i>					
<b>EV9607-01</b>	<b>7DM</b>	0.05 - 0.50	1,600 grains	Demineralizing	<b>GIS # 9607-01</b>
<i>PROBLEM: → High Mineral Content (Low volume application)</i>					
<b>EV9607-04</b>	<b>7SO</b>	.50	2,000 grains	Ion Exchange Resin	<b>GIS # 9607-04</b>
<i>PROBLEM: → Taste &amp; Odor and Mineral Reduction</i>					
<b>EV9607-10</b>	<b>ESO6</b>	0.50	See spec-sheet	3-Stage Blending	--
<b>EV9607-25</b>	<b>ESO7</b>	0.50	See spec-sheet	3-Stage Blending	--
<i>PROBLEM: → Acidic (Low pH) Water</i>					
<b>EV9607-02</b>	<b>7NE</b>	0.50	--	Buffering	<b>GIS # 9607-02</b>
<i>PROBLEM: → Iron &amp; Sulfur</i>					
<b>EV9607-03</b>	<b>7OF</b>	0.50	--	Oxidizing	<b>GIS # 9607-03</b>
<i>PROBLEM: → Chloramines</i>					
<b>EV9105-02</b>	<b>CC1E</b>	5.00	15,000	Granular Activated Carbon	<b>GIS # 9105-02</b>
<i>4C-X Filter (for cold cup vending machine applications)</i>					
<b>EV9590-06</b>	<b>4C-X</b>	0.50	--	Pleated Septum	<b>N/S</b>
<i>PROBLEM: → Iron</i>					
<b>150467</b>	<b>Big Blue Housing</b>			See specification Sheet	
<b>155263-43</b>	<b>RFFE-20BB Cartridge</b>			See specification Sheet	<b>N/S</b>



7TO 7DM 7SO  
ESO6 ESO7 7NE



7OF CC1E 4C-X



Big Blue & RFFE-20BB



### Replacement Cartridges for 3M / Cuno Series 5000 & 8000 Systems

Vendor #	Cartridge ID	Micron Rating	Flow Rate (gpm)	Rated Capacity (gallons)	SYSTEM #
<b>EV9751-11</b>	EFS5002-K	5.0	1.00	4,000	<b>GIS # 9751-11</b>
<b>EV9781-10</b>	EFS8002	5.0	1.50	10,000	<b>GIS # 9781-10</b>
<b>EV9781-12</b>	EFS8002-S	5.0	1.50	10,000	<b>GIS # 9781-12</b>

N/S = Non-Stocked Item, requires special order and lead time.

Filter System Cartridge Kits

# Water Filtration

## EVERPURE®

**Remember:  
Replace Filter Cartridges  
Every 6 Months**



# Filter System Cartridge Kits

**Triple MC2 Cartridge Kit**  
For EV9328-06 MC2 System  
**EV9970-42**  
GIS # 9970-42



**Quad MC2 Cartridge Kit**  
For EV9437-10 MC2 System  
**EV9628-28**  
--



**Quad XC2 Cartridge Kit**  
For EV9437-10 MC2 System  
**EV9628-29**  
GIS # 9628-29

Replace MC2 Cartridges w/ XC2 Kit for extra capacity.



**Twin 7CLM+ Cartridge Kit**  
For EV9771-32 System  
**EV977132RCK**  
--



**Triple 7CLM+ Cartridge Kit**  
For EV9771-33 System  
**EV977133RCK**  
--



**Quad 7CLM+ Cartridge Kit**  
For EV9771-34 System  
**EV977134RCK**  
--



**Twin Endurance Cartridge Kit**  
For EV9437-30 Endurance  
**EV9628-70**  
N/S



**Triple Endurance Cartridge Kit**  
For EV9437-31 Endurance  
**EV9628-71**  
--



**Quad Endurance Cartridge Kit**  
For EV9437-32 Endurance  
**EV9628-72**  
--



N/S = Non-Stocked Item, requires special order and lead time.



Quest Elite Juice Dispensers

# Quest Elite 2000 CURVE



- 2-flavor with wide product/ratio capability.
- Cup clearance 7".
- 115/60 voltage.
- Frost-free refrigeration compartment.
- Large 6-8lb ice bank for cold drinks during peak demand.
- LED illuminated juice graphic.
- 10.5" narrow footprint to conserve counter space.
- Sold Out indicator to alert when product is empty.
- Quality drinks with no stratification, slugging, or dripping.
- NON-Flushing (optional).
- Accommodates frozen, ambient, concentrate containers, or BIB.

R290A Refrigerant

Model	Part #	Product Description
<b>Quest Elite 2 Juice Dispenser, Curve</b>		10.5" Width x 24.5" Depth x 34" Height
<b>Quest Elite 2000C</b>	<b>721Q12101</b>	2-Flavor, SLJ Platform, Non-flush, Sold Out, Push Button, Illuminated

# Quest Elite 4000 CURVE



- 4-flavor with wide product/ratio capability.
- Cup clearance 7".
- 115/60 voltage.
- Frost-free refrigeration compartment.
- Large 14-16lb ice bank for peak demand.
- LED illuminated juice graphic.
- 15.2" narrow footprint to conserve counter space.
- Sold Out indicator to alert when product is empty.
- Quality drinks with no stratification, slugging, or dripping.
- NON-Flushing (optional).
- Accommodates frozen, ambient, concentrate containers, or BIB.

R290A Refrigerant

Model	Part #	Product Description
<b>Quest Elite 4 Juice Dispenser, Curve</b>		15.2" Width x 24.9" Depth x 34" Height
<b>Quest Elite 4000C</b>	<b>721Q14101</b>	4-Flavor, SLJ Platform, Non-flush, Sold Out, Push Button, Illuminated

Part #	Quest Accessory Description
720401107	Refillable bottle assembly
729011126	2-flavor remote BIB conversion kit
729011125	4-flavor remote BIB conversion kit
729011004	2-flavor tall cup adaptor kit
729011003	4-flavor tall cup adaptor kit

Part #	Quest Accessory Description
729011183	Single valve extended nozzle kit
720401313	QE2 curved generic merchandiser
720401319	QE4 curved generic merchandiser

Quest Elite Juice Dispensers

# Quest Elite 2000



- 2-flavor with wide product/ratio capability.
- Cup clearance 7".
- 115/60 voltage.
- Frost-free refrigeration compartment.
- Large 6-8lb ice bank for cold drinks during peak demand.
- LED illuminated juice graphic.
- 10.5" narrow footprint to conserve counter space.
- Sold Out indicator to alert when product is empty.
- Quality drinks with no stratification, slugging, or dripping.
- **NON-Flushing.**
- Accommodates frozen, ambient, concentrate containers, or BIB.



2-flavor push-button dispense.

Model	Part #	Product Description
Quest Elite 2 Juice Dispenser		10.5" Width x 24.5" Depth x 34" Height
Quest Elite 2000	<b>721Q02101JU1</b>	2-Flavor, SLJ Platform, Non-flush, Sold Out, Push Button, Illuminated

# Quest Elite 4000



- 4-flavor with wide product/ratio capability.
- Cup clearance 7".
- 115/60 voltage.
- Frost-free refrigeration compartment.
- Large 14-16lb ice bank for peak demand.
- LED illuminated juice graphic.
- 15.2" narrow footprint to conserve counter space.
- Sold Out indicator to alert when product is empty.
- Quality drinks with no stratification, slugging, or dripping.
- **NON-Flushing.**
- Accommodates frozen, ambient, concentrate containers, or BIB.



4-flavor push-button dispense.

Model	Part #	Product Description
Quest Elite 4 Juice Dispenser		15.2" Width x 24.9" Depth x 34" Height
Quest Elite 4000	<b>721Q04101JU1</b>	4-Flavor, SLJ Platform, Non-flush, Sold Out, Push Button, Illuminated

Part #	Quest Accessory Description
720401107	Refillable bottle assembly
729011126	2-flavor remote BIB conversion kit
729011125	4-flavor remote BIB conversion kit
729011004	2-flavor tall cup adaptor kit
729011003	4-flavor tall cup adaptor kit



Part #	Quest Accessory Description
729011183	Single valve extended nozzle kit
729011218	2-flavor portion ctl conversion kit
729011220	4-flavor portion ctl conversion kit
629097144	2-flavor ADA conversion kit
629097145	4-flavor ADA conversion kit

Quest Elite Juice Dispensers

# Quest Elite 2000 Multi-Flavor



- 2-flavor with wide product/ratio capability.
- Cup clearance 7".
- 115/60 voltage.
- Frost-free refrigeration compartment.
- Large 6-8lb ice bank for cold drinks during peak demand.
- LED illuminated Multi-Panel merchandiser.
- 10.5" narrow footprint to conserve counter space.
- **NO** Sold Out indicator.
- Quality drinks with no stratification, slugging, or dripping.
- **NON**-Flushing.
- Accommodates frozen, ambient, concentrate containers, or BIB.

**Multi-Panel Model**

R290A Refrigerant

These units can dispense juices w/ pulp, teas, and cold coffees

Non-Stocked

Model

Part #

\*\*\* This model is a Non-Stocked Item: requires special order and lead time

Quest Elite 2 Juice Dispenser

10.5" Width x 24.5" Depth x 34" Height

Quest Elite 2000

721Q02101JU2

2-Flavor, SLJ Platform, Push Button, Illuminated Multi-Panel



# Quest Elite 4000 Multi-Flavor

- 4-flavor with wide product/ratio capability.
- Cup clearance 7".
- 115/60 voltage.
- Frost-free refrigeration compartment.
- Large 14-16lb ice bank for peak demand.
- LED illuminated Multi-Panel merchandiser.
- 15.2" narrow footprint to conserve counter space.
- **NO** Sold Out indicator.
- Quality drinks with no stratification, slugging, or dripping.
- **NON**-Flushing.
- Accommodates frozen, ambient, concentrate containers, or BIB.

**Multi-Panel Model**

R290A Refrigerant



Model

Part #

Product Description

Quest Elite 4 Juice Dispenser

15.2" Width x 24.9" Depth x 34" Height

Quest Elite 4000

721Q04101JU2

4-Flavor, SLJ Platform, Push Button, Illuminated Multi-Panel

Part #	Quest Accessory Description
720401107	Refillable bottle assembly
729011126	2-flavor remote BIB conversion kit
729011125	4-flavor remote BIB conversion kit
729011004	2-flavor tall cup adaptor kit
729011003	4-flavor tall cup adaptor kit

Part #	Quest Accessory Description
729011183	Single valve extended nozzle kit
729011218	2-flavor portion ctl conversion kit
729011220	4-flavor portion ctl conversion kit
629097144	2-flavor ADA conversion kit
629097145	4-flavor ADA conversion kit

JDF Juice Dispensers



- Segmented Graphic Door to promote flavors.
- Cup clearance 7".
- Frost-free refrigeration compartment.
- Flow Rate: 1.0 TO 1.5 Oz per second.
- Illuminated Multi-Panel merchandiser.
- Includes 4" Legs.
- Includes Air Filter.
- Includes variety pack of 8-graphics.
- Has a service friendly design.
- Refrigerant: R134A.
- 120/60 voltage.
- Door lock is standard.



Part #	Description	
--------	-------------	--

**JDF-2S PB Juice Dispenser**

<b>37900.0076</b>	2-Flavor Juice Dispenser w/ Water	
-------------------	-----------------------------------	--

10.5" Width x 27.3" Depth x 33.4" Height

- 2-Product, Push Button.
- 2 Segment Graphic Door.
- Ice Bank: 8 lbs.
- Includes 1 cold water dispense.



Part #	Description	
--------	-------------	--

**JDF-4S PB Juice Dispenser**

<b>37300.0079</b>	4-Flavor Juice Dispenser	
-------------------	--------------------------	--

15.7" Width x 27.5" Depth x 33.1" Height

- 4-Product, Push Button.
- 4 Segment Graphic Door.
- Ice Bank: 18 lbs.



Part #	Description	
--------	-------------	--

**JDF-4S PC Juice Dispenser**

<b>37300.0080</b>	4-Flavor Juice Dispenser	
-------------------	--------------------------	--

15.7" Width x 27.5" Depth x 33.1" Height

- 4-Product, Portion Control.
- 4 Segment Graphic Door.
- Ice Bank: 18 lbs.



Part #	Description	
--------	-------------	--

**JDF-4S PB Juice Dispenser**

<b>37300.0094</b>	4-Flavor Juice Dispenser w/ Water	
-------------------	-----------------------------------	--

15.7" Width x 27.5" Depth x 33.1" Height

- 4-Product, Push Button.
- 4 Segment Graphic Door.
- Ice Bank: 18 lbs.
- Includes 1 cold water dispense.

These models are Non-Stocked Items: requires special order and lead time.

Classic Bubbler Dispensers

# Cold Beverage

- Premix Cold Beverage Dispenser.
- Cup clearance 8.25".
- 115/60 voltage.
- Classified as a classic bubbler.
- Refrigerant: R134A.
- 1/6 HP Refrigeration.
- Temperature Range: 35F to 41F.
- Easy cleaning and maintenance.
- Certified NSF/ANSI20 (Safe for Milk).
- For juices, Coffee, or Tea.

## VISUAL DISPLAY DISPENSERS



D15-3



D15-4

Model	Part #	Product Description
<b>Cold Beverage Dispenser</b>		10.25" Width x 16" Depth x 27.25" Height
D15-3	D15-3	Single Bowl, 5-Gallon, <u>Stainless Steel</u> Side Panels and Drip Tray
D15-4	D15-4	Single Bowl, 5-Gallon, <u>White Plastic</u> Side Panels and Drip Tray

- Premix Cold Beverage Dispenser.
- Cup clearance 8.25".
- 115/60 voltage.
- Classified as a classic bubbler.
- Refrigerant: R134A.
- 1/5 HP Refrigeration.
- Temperature Range: 35F to 41F.
- Easy cleaning and maintenance.
- Certified NSF/ANSI20 (Safe for Milk).
- For juices, Coffee, or Tea.



D25-3



D25-4

Non-Stocked

Model	Part #	Product Description <i>(Not a system item: Not Stocked)</i>
<b>Cold Beverage Dispenser</b>		17.5" Width x 16" Depth x 27.25" Height
D25-3	D25-3	Twin Bowls, 5-Gallon, <u>Stainless Steel</u> Side Panels and Drip Tray
D25-4	D25-4	Twin Bowls, 5-Gallon, <u>White Plastic</u> Side Panels and Drip Tray

Note: The two models listed above are non-stocked products that require a leadtime from the manufacturer.

Along with spray circulation, agitators are included with each unit. NEMA 5-15P power cord included. Ships as two boxes (Base and Bowls).

**CRATHCO  
GRINDMASTER**

SIMPLICITY Bubbler Dispensers

Cold Beverage

**VISUAL DISPLAY DISPENSERS**

Note: These models are inventory items but are non-stocked products that require a leadtime from the manufacturer.

**CS-1D-16**



Part #

Description

**Single Bowl Cold Beverage Dispenser**

**CS-1D-16**

SIMPLICITY Bubbler Dispenser

10.5" Width x 18.5" Depth x 27.5" Height

- Premix Cold Beverage Dispenser.
- Cup clearance 9".
- 120/60 voltage.
- Stainless steel base.
- \*\* 2 bowl options (Poly or BPA Free).
- Dispenses (1) Flavor.

**CS-2E-16**



Part #

Description

**Twin Bowl Cold Beverage Dispenser**

**CS-2E-16**

SIMPLICITY Bubbler Dispenser

10.5" Width x 18.5" Depth x 27.5" Height

- Premix Cold Beverage Dispenser.
- Cup clearance 9".
- 120/60 voltage.
- Stainless steel base.
- \*\* 2 bowl options (Poly or BPA Free).
- Dispenses (2) Flavors.

**CS-4E-16**



Part #

Description

**Mini-Quad Cold Beverage Dispenser**

**CS-4E-16**

SIMPLICITY Bubbler Dispenser

20.5" Width x 17.75" Depth x 27.5" Height

- Premix Cold Beverage Dispenser.
- Cup clearance 9".
- 120/60 voltage.
- Stainless steel base.
- \*\* 2 bowl options (Poly or BPA Free).
- Dispenses (4) Flavors.

Agitators included with each unit. NEMA 5-15P power cord included. 4" legs included. Ships as two boxes (Base and Bowls).

Cold Coffee Dispenser

Cold Beverage

**nitropro™ mini**  
Specialty Beverage Dispenser



- LED illuminated merchandiser with easy change graphic.
- Onboard Gas Generator - no need to source nitrogen.
- Bag-in-Box Technology - No brewing or manual mixing.
- Programmed Mixing Ratios - ensures accuracy and saves time.
- Narrow Footprint - self-contained design that conserves space.
- Dual Tap Design - dispense chilled nitro and still product - 1 BIB.
- Easy to remove handles - replace to align with your brand.
- Frost-Free Refrigeration Compartment.
- Adjustable ratios from 3:1 to 7:1.
- 115v /60hz.

Chilled Nitro-infused  
Cold Coffee, Specialty  
Beverage, or Cold Brew

Model	Part #	Product Description
NitroPro Mini Speciality Dispenser		10.4" Width x 25.9" Depth x 34" Height
NitroPro Mini	721Q26434CNB	Dual tap design, LED illuminated merchandiser, 1-gallon BIB cap.

**nitropro™ mini**  
Accessories

Part #	Accessory Description
620068154	Optional 90psi water booster pump 115v/60hz
629097835	Annual preventative maintenance kit
629097834	Replacement nozzle, mixing cap, and O-ring
620067410	Product delivery hose assembly (Scholle 1910L)

Designed for BIB product delivery.  
Just connect and serve

Note: This is a frequently purchased item and stock status changes frequently. As such, this model might not be in stock at time of order and may require a leadtime from the manufacturer.



Frozen Carbonated Beverage Dispensers



- All units are 230v/60hz.
- Syrup flexibility with pressure transducer technology.
- Programmable sleep mode for off hours to conserve energy.
- Meet ADA compliance using the SPH valve models.
- Use Motorman valve models for Frozen Uncarbonated Beverages (FUB).
- Intelligent defrost function for peak demand.
- Superior engineering with advanced technology.

Model	Part #	Type of Valves	Merchandiser Type	Measurements
<b>Viper Elite Classic 2 Flavor</b>				R448A Refrigerant
<b>Viper 2</b>	<b>621266142</b>	SPH	Tall	17" Width x 32.5" Depth x 43.7" Height
<b>Viper Elite Classic 3 Flavor</b>				R448A Refrigerant
<b>Viper 3</b>	<b>621366142</b>	SPH	Tall	22.7" Width x 32.5" Depth x 43.7" Height
<b>Viper Elite Classic 4 Flavor</b>				R448A Refrigerant
<b>Viper 4</b>	<b>621466142</b>	SPH	Tall	29" Width x 32.5" Depth x 43.7" Height



Viper 2  
(TALL)



Viper 3  
(TALL)



Viper 4  
(TALL)

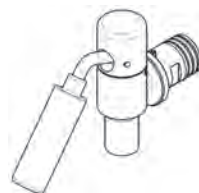

SPH Valve  
(Stainless Push Handle)

Note: These are frequently purchased items and stock status changes frequently. As such, one or more of these models might not be in stock at time of order and may require a leadtime from the manufacturer.



Frozen Carbonated Beverage Dispensers

# VIPER Carts

- Stainless steel side panels.
- Cabinet storage for BIB syrups and pumps.
- All Viper carts come with casters.
- Carts designed for use with Viper FCB models.



Buck & Boost Transformer  
(Part # 620067479)

<b>Viper 2 Cart</b>
Part # <b>620043075</b>
17" Width x 31.7" Depth x 32" Height

<b>Viper 3 Cart</b>
Part # <b>620053990</b>
22.7" Width x 31.7" Depth x 32" Height

<b>Viper 4 Cart</b>
Part # <b>620046556</b>
29" Width x 31.7" Depth x 32" Height

## Viper Graphics

Part #	Description	
620042822	Viper 2 Tall merchandiser generic graphic	N/S
620046410	Viper 3 Tall merchandiser generic graphic	N/S
620046477	Viper 4 Tall merchandiser generic graphic	N/S

N/S = Non-Stocked Item, requires special order and lead time.



## Viper Flavor Card Kits

Part #	Description	
620042868	Generic flavor cards (18 flavors)	N/S
620051378	Coca-Cola flavor cards	N/S
620051379	Pepsi flavor cards	N/S



620042868

620051378



620051379

Note: There are Viper installation components that maybe required and are not listed in this catalog. Due to the complexity of installing FCB units, ask our sales department for information and guidance.



Frozen Carbonated Beverage Dispensers



- All units are 200 to 245 VAC single phase, 3-wire.
- InlineCarbonation - creates consistent over-run, quality and yield.
- AccuFreeze - delivers consistent frozen beverages.
- RapidFreeze - cold chamber system improves recovery and draw-time.
- Electronic simplicity offers easy-to-use keypad.
- Dispense carbonated and noncarbonated beverages with individual barrels.
- Simple design delivers extreme reliability using fewer parts.

Model	Description	Measurements
<b>772 FBD 2 Flavor, Air Cooled, Tall Door</b>		R448A Refrigerant
<b>772-611-0004</b>	2-flavor frozen beverage dispenser	17" Width x 32.38" Depth x 41.40" Height
<b>773 FBD 3 Flavor, Air Cooled, Tall Door</b>		R448A Refrigerant
<b>773-611-0001</b>	3-flavor frozen beverage dispenser	20.25" Width x 32.38" Depth x 41.40" Height
<b>774 FBD 4 Flavor, Air Cooled, Tall Door</b>		R448A Refrigerant
<b>774-611-0001</b>	4-flavor frozen beverage dispenser	26" Width x 32.38" Depth x 41.40" Height



FBD 772



FBD 773



FBD 774

FBD Graphics

Part #	Description	
FBD24-772G-T004	FBD 2 Tall merchandiser generic graphic	N/S
FBD24-773G-T004	FBD 3 Tall merchandiser generic graphic	N/S
FBD24-774G-T004	FBD 4 Tall merchandiser generic graphic	N/S

FBD Flavor Card Kits

Part #	Description	
FBD24-2095-0014	FBD Flavor Cards, Assortment	N/S

N/S = Non-Stocked Item, requires special order and lead time.



Buck & Boost Transformer  
(Part # FBD14-0378-0005)

Frozen Carbonated Beverage Dispensers

<b>FBD 772 Cart</b>
Part # <b>12-2493-0001</b>
17" Width x 34.1" Depth x 34.6" Height

<b>N/S</b>

<b>FBD 773 Cart</b>
Part # <b>12-2516-0001</b>
20.25" Width x 34.1" Depth x 32" Height

<b>N/S</b>

<b>FBD 774 Cart</b>
Part # <b>12-2899-0001</b>
26 Width x 32.8" Depth x 34.63" Height

<b>N/S</b>

N/S = Non-Stocked Item, requires special order and lead time.

FBD 372



FBD 373



FBD Leg Set, Universal  
(Part # 12-2533-0001)

Model	Description	Measurements
<b>372 FBD 2 Flavor, Air Cooled, Tall Door</b>		<b>R448A Refrigerant</b>
<b>372-611-0010</b>	2-flavor frozen beverage dispenser	15.8" Width x 25.2" Depth x 37.7" Height
<b>373 FBD 3 Flavor, Air Cooled, Tall Door</b>		<b>R448A Refrigerant</b>
<b>373-611-0003</b>	3-flavor frozen beverage dispenser	20.1" Width x 25.2" Depth x 37.7" Height

- Designed for small spaces.

Note: The models listed above are non-stocked products that require a leadtime from the manufacturer.

Frozen Carbonated Beverage Dispensers



- This unit is 200 to 245 VAC single phase, 3-wire.
- InlineCarbonation - creates consistent over-run, quality and yield.
- AccuFreeze - delivers consistent frozen beverages.
- RapidFreeze - cold chamber system improves recovery and draw-time.
- Dispense carbonated and noncarbonated beverages with individual barrels.
- Simple design delivers extreme reliability using fewer parts.

R448A Refrigerant

Part #	Description
--------	-------------

**772 FBD Multi-Flavor, Air Cooled, Tall Door**

<b>772-611-0003</b>	Multi-Flavor frozen beverage dispenser
---------------------	--

17" Width x 32.5" Depth x 41.4" Height



- Flavor Selection by a 13.3" Touch Screen

Note: The model listed above is a non-stocked product that require a leadtime from the manufacturer.



Gourmet Frozen Beverage Dispensers

# Slush Machines Ultra NX Frozen Beverage System

- Two large 3gal (11.4L) hoppers for optimum cooling and serving capacity.
- Enhanced “no-lube” design on faucets and seals which simplifies installation and cleaning.
- Refrigeration system internally monitored to ensure long lasting performance.
- Reversing auger design quickens freeze time and reduces air mixing.
- Very simple to program and run with touchpad display, which also guides cleaning and preventive maintenance.
- All models listed below have extended dispense handles and 4” black legs.

### ULTRA NX, Manual Fill, Extended Length Handles

16” Width x 24.5” Depth x 32” Height

Part #	Description
<b>58000.0000</b>	2-hoppers, white/stainless finish, manual fill
<b>58000.0010</b>	2-hoppers, all black finish, manual fill
<b>58000.0015</b>	2-hoppers, black/stainless finish, manual fill

All models are  
120v / 60hz

### ULTRA NX CFV (Liquid Autofill w/ Contant Flow Valve), ELH

16” Width x 24.5” Depth x 32” Height

Part #	Description
<b>58000.0011</b>	2-hoppers, all black finish, autofill w/ contant flow valve
<b>58000.0016</b>	2-hoppers, black/stainless finish, autofill w/ contant flow valve



White and  
Stainless Exterior



All Black Exterior



Black and  
Stainless Exterior

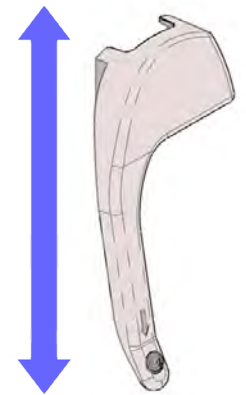

Extended length handles  
(Push to Dispense)



Liquid Autofill w/  
Constant Flow Valve

R290A Refrigerant



Note: The models listed above are non-stocked products that require a leadtime from the manufacturer.

## Multi-Valve Tea Dispensers

- Non-electric ambient tower designed for BIB or fresh brewed concentrate.
- For non-carbonated iced tea, lemonade, cold brewed coffee or other cold based beverage.
- Advanced contactless / push-to-pour valves allow easy dispensing without touching unit.
- Advanced ratio and flow control valves.
- Slim format that is easy to install and service.
- Multiple branding points identified using identification windows on body and on-valve graphics.
- Each model is made of stainless steel construction, are durable, attractive, and easy to clean.
- Each model is shipped with drip tray, fittings, and are ready to install out of box.
- Made in America.

Item #

**2 Flavor Tea Dispenser**

**925-0036**

8" Width x 19" Depth x 22" Height



Branding / Graphic Locations



Item #

**3 Flavor Tea Dispenser**

**925-0035**

11" Width x 19" Depth x 22" Height



Item #

**4 Flavor Tea Dispenser**

**925-0037**

14" Width x 19" Depth x 22" Height



with top removed,  
4 valves and tubing

- For BIB or concentrate

Tea Dispensers

# Tea



## 2 Flavor Tea Tower

Model	Part #	Product Description
<b>2 Flavor Tea Tower Dispenser</b>		7.75" Width x 9.125" Depth x 17.5" Height
<b>2 flavor Tea Tower</b>	<b>620048544</b>	2 flavor Tea or Juice tower, UFB-1 sanitary lever

- One or two flavor capability, UFB-1 valve(s).
- Inlet line access from back or bottom allows easy access.
- Drip tray can be removeable or plumbed.
- Cooling capacity relies on choice of remote cooling unit.
- Syrup is stored in remote containers.
- Simple connections to water and syrup lines.
- Brix ratio adjustment from 4:1 to 6:1.
- Cup clearance 9.75".
- 30 lbs psi minimum water pressure required.
- Electrical requirement is 120v / 60hz / 2amps.



*A dispenser for tea and juices*

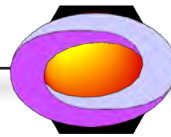

## BUNN®

## Automatic Tea Brewers

### TB3Q Single Tea Brewer (29" Trunk)

Specifications

Model Number	<b>36700.0013</b>
Available in Dual Voltage	No
8oz Cups Tea/Hr	336
120V Cord Set included	Yes
Dimensions	11.6" W x 22" D x 34" H
	<b>N/S</b>

N/S = Non-Stocked Item, requires special order and lead time.

- Quickbrew has shorter brewing cycle.
- Brews directly into any style portable server.
- SplashGard funnel deflects hot liquids away from the hand.
- 120v / 60hz electrical.



 Servers and airpots sold separately

### TB6Q Twin Tea Brewer (29" Trunk)

Specifications

Model Number	<b>36700.0301</b>
Available in Dual Voltage	No
8oz Cups Tea/Hr	336
120V Cord Set included	Yes
Dimensions	12.2" W x 22.6" D x 34" H
	<b>N/S</b>

N/S = Non-Stocked Item, requires special order and lead time.

 Servers and airpots sold separately

- Color coded decals help to align the brew basket, dispenser and choose the correct selection.
- Includes rotating brew basket, base platform adapter, dedicated dilution nozzles and brew switch.
- Specifically designed to accommodate and brew into **two** BUNN 3.5gal Narrow Tea Dispensers
- Can also brew directly into standard single tea dispensers.
- SplashGard funnel deflects hot liquids away from the hand.
- 120v / 60hz electrical.



Other model configurations available.

Note: The models listed above are non-stocked products that require a leadtime from the manufacturer.



# BUNN®

## ITCB-DV Coffee or Tea Brewer

ITCB-DV Coffee or Tea Brewer w/ Tray (29" Trunk)	
Specifications	
Model Number	<b>52200.0100</b>
Available in Dual Voltage	Yes
16oz Cups Coffee/Hr	36 cups @120V / 60 cups @ 240V
16oz Cups Tea/Hr	213 cups @120V / 213 cups @ 240V
120V Cord Set included	Yes
208/240 Cord Set included	No, Customer Provided
Dimensions	11.6" W x 21.8" D x 35" H
	<b>N/S</b>



N/S = Non-Stocked Item, requires special order and lead time.

- Sleek modern design with rounded angles.
- Digital readout - program adverts for display and shows machine status.
- Infusion technology allows multiple recipes from one footprint.
- Brews into all Bunn ice tea dispensers (except TDS-5), 1.9 to 3.8 liter airpots and thermo carafes.
- Includes intergrated flip tray that converts to three positions: carafes, airpots, and tea dispensers.
- 120v / 60hz (cord included) or 208-240v / 60hz (cord not included) electrical.

Servers and airpots sold separately  
Other model configurations available.



<b>TD3T-N - Brew thru Lid</b> 3.5 Gal Tea / Coffee Disp.
Part # 43900.0001
TB3Q / TB6Q / ITCB-DV
<b>N/S</b>

<b>TD3T-N - Solid Lid</b> 3.5 Gal Tea / Coffee Disp.
Part # 43900.0002
TB3Q / TB6Q / ITCB-DV
<b>N/S</b>

<b>TF Server 1 Gal, No base</b> Mechanical Sight Gauge
Part # 44000.0250
For ITCB-DV
<b>N/S</b>

Base (part # 54473.0000) Sold Separately

N/S = Non-Stocked Item, requires special order and lead time.

The variety of products for use with the TB3Q, TB6Q, and ITCB-DV are numerous and aren't shown in this catalog (ask a sales person based on your need).

**Tea / Coffee Brewer Accessories**

**Funnel Assy, Smoke-Tea**  
**Part # 03021.0005**  
 For TB3Q



**N/S**

**Funnel Assy, Smoke-Tea**  
**Part # 03021.0014**  
 For TB6Q



**N/S**

**Filters Tea, 500 Pack**  
**Part # 20100.0000**  
 For TB3Q and TB6Q



**N/S**

**Filters Gourmet, 500 Pack**  
**Part # 20138.1000**  
 For ITCB-DV



**N/S**

**Funnel Assy, Coffee Blk**  
**Part # 53463.0021**  
 For ITCB-DV



**N/S**

**Thermal Carafe 1.9L Blk**  
**Part # 36029.0001**  
 For ITCB-DV



**N/S**

**Thermal Carafe 1.9L Org**  
**Part # 36252.0001**  
 For ITCB-DV



**N/S**

**Airpot 2.5L GL PB**  
**Part # 13041.0001**  
 For ITCB-DV



**N/S**

**Airpot 2.5L SST LA**  
**Part # 32125.0000**  
 For ITCB-DV



**N/S**

**Airpot 3.0L SST LA**  
**Part # 32130.0000**  
 For ITCB-DV



**N/S**

**TDS-3.5 - 3.5gal Reservoir**  
**Part # 33000.0008**  
 TB3Q / TB6Q / ITCB-DV



**N/S**

**TDO-N-3.5, 3.5gal Reservoir**  
**Part # 39600.0001**  
 TB3Q / TB6Q / ITCB-DV



**N/S**

The variety of products for use with the TB3Q, TB6Q, and ITCB-DV are numerous and aren't shown in this catalog (ask a sales person based on your need).

N/S = Non-Stocked Item, requires special order and lead time.

Cappuccino Dispenser

# Cappuccino

# BUNN®

## iMix-3S+ Cappuccino Dispenser SILVER SERIES

- 4.3gal (16.3L) hot water tank to meet peak serving times
- High efficiency LED lighted front graphics for merchandising
- Alphanumeric display allows adjustments and service operational testing from front of machine. Also communicates advertising messages, machine status and technical support contact information
- Can be set as push and hold or single size portion control
- Capacity: Three 8lb (3.6kg) hoppers
- Cup clearance at 7.25" (18.4cm) to accommodate popular cup sizes [adjustable to 8.12" (20.6cm)]
- Easily removable side panels for complete access to service components
- Front of machine access to tank drain, dump valves, auger and whipper motors.
- High speed heavy-duty whipper for complete product mixing
- Spring-loaded, all metal auger drive system for easy hopper installation
- Variable speed motors allow control of product consistency in mixing chamber (.75 to 6.6 grams of powder per second)

**Hot**  
add ice to make  
*Cold Beverage*

### iMix 3S+ Cappuccino Dispenser

There are various product numbers for this item. When ordering reference one of the model numbers below. Additionally, there are many model configurations available.

Model Numbers	<b>38600.0050</b>
Dimensions	12.6" W x 24.1" D x 32.8" H
	<b>N/S</b>

N/S = Non-Stocked Item, requires special order and lead time.

 <p>DISPLAY GRAPHICS IMIX-3</p> <p>Product #: 37457.0000</p>	 <p>DISPLAY GRAPHICS CHAI TEA</p> <p>Product #: 37457.0001</p>	 <p>DISPLAY GRAPHICS HOT CHOC</p> <p>Product #: 37457.0002</p>
 <p>DISPLAY GRAPHICS STEAMERS</p> <p>Product #: 37457.0003</p>	 <p>DISPLAY GRAPHICS ICED CAP</p> <p>Product #: 37457.0006</p>	



Other model configurations available.

## Axiom Decanter Brewers

# BUNN®

- Adjusts automatically to varying water pressure.
- Automatic warmer shut-off.
- Electronic diagnostics and built-in tank drain make service easier.
- Large 200oz (59L) tank provides back-to-back brewing capacity.
- For high lime areas, BrewLOGIC technology calculates flow rate and adjusts brew time to maintain consistent pot levels.
- Ensure coffee quality with programming for brew level, cold brew lockout and tank temperature, set easily from the front of the machine.
- Coffee extraction controlled with programmable pre-infusion, pulse brew and digital temperature precision.
- Energy-saver mode reduces tank temperature during idle periods.
- Hot water faucet.
- SplashGard funnel deflects hot liquids away from the hand.

### Axiom-15-3

There are various product numbers for this item. When ordering reference one of the model numbers below. Additionally, there are other configurations available.

Model Number	<b>38700.0000</b>
Available in Dual Voltage	No
16oz Cups Coffee/Hr	33 cups @ 120V
120V Cord Set included	Yes
Dimensions	8.4" W x 22.1" D x 18.9" H
	<b>N/S</b>

N/S = Non-Stocked Item, requires special order and lead time.



 Servers and airpots sold separately



## Infusion Coffee Brewer

- Sleek modernized design with rounded angles on the corners and trunk.
- Brews into 2.5 to 3.8L (84 to 128oz) airpots and 3.8 and 5.7L (1 to 1.5gal) baseless ThermoFresh servers for easy transport of coffee to other locations.
- Three brew buttons allow for 3 separate brewing profiles. Two programmable batch switches allow full and half batch brewing.
- Electronic funnel lock prevents removal of each brew funnel until brew funnel until drip-through is complete.
- Digital display for easier programming and control. Advertising messages and machine status also displayed.
- Pre-infusion and pulse brew for maximum flavor extraction.
- Dual voltage adaptable (Can operate at 120V/15 amp or 120/208-240V/20 amp).
- USB programming capable.
- Brew counter keeps track of how many batches are brewed.
- Energy-saver mode reduces tank temperature during idle periods.
- Hot water faucet (supplied for custom installation).



<b>ICB-DV TALL (Newer version)</b>	
Specifications	
Model Number	<b>53100.0101</b>
Available in Dual Voltage	Yes
16oz Cups Coffee/Hr	40 cups @ 120V / 95 cups @ 240V
120V Cord Set included	Yes
208/240 Cord Set included	No, Customer Provided
Dimensions	10.2" W x 22" D x 35" H
	<b>N/S</b>

N/S = Non-Stocked Item, requires special order and lead time.

 Servers and airpots sold separately



<b>TF Server 1 Gal, No base</b>
<b>Mechanical Sight Gauge</b>
<b>Part # 44000.0250</b>
<b>ITCB-DV / ICB-DV TALL</b>

<b>N/S</b>



N/S = Non-Stocked Item, requires special order and lead time.

# BUNN®



### Coffee Brewer Accessories

**Funnel Assy, Coffee Blk**  
**Part # 20583.0003**  
 For Axiom models



**N/S**

**Funnel Assy, Coffee Blk**  
**Part # 53463.0021**  
 For ICB-DV TALL



**N/S**

**Filters Regular, 500 Pack**  
**Part # 20100.0000**  
 For Axiom models



**N/S**

**Filters Gourmet, 500 Pack**  
**Part # 20138.1000**  
 For ICB-DV TALL



**N/S**

**Decanter, Coffee Blk**  
**Part # 42400.0101**  
 For Axiom models



**N/S**

**Decanter, Coffee Org**  
**Part # 42401.0101**  
 For Axiom models



**N/S**

**Easy Pour, SS Base, Blk**  
**Part # 06100.0101**  
 For Axiom models



**N/S**

**Easy Pour, SS Base, Org**  
**Part # 06101.0101**  
 For Axiom models



**N/S**

**Server w/base, 1gal, DSG**  
**Part # 42700.0200**  
 For ICB-DV TALL



**N/S**

**Server w/base, 1.5gal, DSG**  
**Part # 42750.0200**  
 For ICB-DV TALL



**N/S**

**Server w/base, 1gal, Mech**  
**Part # 44000.0200**  
 For ICB-DV TALL



**N/S**

**Server w/base, 1.5gal, Mec**  
**Part # 44050.0200**  
 For ICB-DV TALL



**N/S**

N/S = Non-Stocked Item, requires special order and lead time.

## Bar Guns

### Post-Mix Bar Guns

M4 Flexhose Bar Dispensers

### Wunder-Bar



Product #	Total # of Buttons	Carb Buttons	Non-Carb Buttons	Soda / Water
<b>Seven Button Bar Gun</b>				
M4-7500KSF3	7	5	0	2
<b>Eight Button Bar Gun</b>				
M4-8510KSF3	8	5	1	2
M4-8600KSF3	8	6	0	2
<b>Ten Button Bar Gun</b>				
M4-10440KSF3	10	4	4	2
M4-10530KSF3	10	5	3	2
M4-10620KSF3	10	6	2	2
<b>Twelve Button Bar Gun</b>				
M4-12460KSF3	12	4	6	2
M4-12550KSF3	12	5	5	2
M4-12640KSF3	12	6	4	2
<b>Fourteen Button Bar Gun</b>				
M4-14660KSF3	14	6	6	2
M4-14750KSF3	14	7	5	2
M4-14840KSF3	14	8	4	2

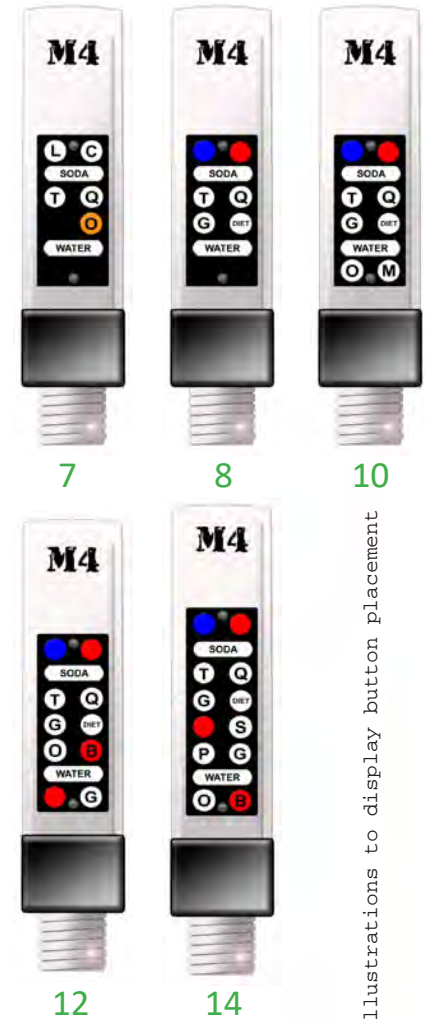

Illustrations to display button placement



- Barguns work with any bag-in-box system.
- 36" stainless steel flexhose with hardened handle casing.
- Additional 48-56-60-72-84 inch flexhose lengths available. *Replace the 3 with a 4 to designate 48" hose and so on.*
- Easy flow control adjustment.
- Self-rinsing nozzle cup.
- NSF and ETL sanitation certified.
- Recirculation bargun.
- Fully hydraulic with no electronic parts.



8-Product Manifold



10-Product Manifold



12-Product Manifold



14-Product Manifold

Note: Red and Blue handle models are available (not shown)

Black Nozzle and Heel

## Bar Guns

### Post-Mix Bar Guns

M4 Flexhose Bar Dispensers

### Wunder-Bar



Product #	Total # of Buttons	Carb Buttons	Non-Carb Buttons	Soda / Water
<b>Seven Button Bar Gun</b>				
M4-7500KSM3	7	5	0	2
<b>Eight Button Bar Gun</b>				
M4-8510KSM3	8	5	1	2
M4-8600KSM3	8	6	0	2
<b>Ten Button Bar Gun</b>				
M4-10440KSM3	10	4	4	2
M4-10530KSM3	10	5	3	2
M4-10620KSM3	10	6	2	2
<b>Twelve Button Bar Gun</b>				
M4-12460KSM3	12	4	6	2
M4-12550KSM3	12	5	5	2
M4-12640KSM3	12	6	4	2
<b>Fourteen Button Bar Gun</b>				
M4-14660KSM3	14	6	6	2
M4-14750KSM3	14	7	5	2
M4-14840KSM3	14	8	4	2



7 8 10

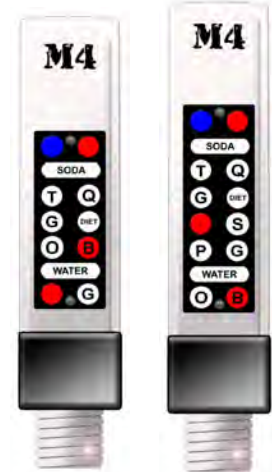

12 14

Illustrations to display button placement



Black Nozzle and Heel

- Barguns work with any bag-in-box system.
- 36" stainless steel flexhose with hardened handle casing.
- Additional 48-56-60-72-84 inch flexhose lengths available. *Replace the 3 with a 4 to designate 48" hose and so on.*
- Mechanical adjustment.
- Self-rinsing nozzle cup.
- NSF and ETL sanitation certified.
- Recirculation bargun.
- Fully hydraulic with no electronic parts.



Standard Manifold

Note: Red and Blue handle models are available (not shown)



## Bar Guns

### Post-Mix Bar Guns

M4 Flexhose Bar Dispensers

### Wunder-Bar



Product #	Total # of Buttons	Carb Buttons	Non-Carb Buttons	Soda / Water
<b>Seven Button Bar Gun</b>				
M4-7500KSN3	7	5	0	2
<b>Eight Button Bar Gun</b>				
M4-8510KSN3	8	5	1	2
M4-8600KSN3	8	6	0	2
<b>Ten Button Bar Gun</b>				
M4-10440KSN3	10	4	4	2
M4-10530KSN3	10	5	3	2
M4-10620KSN3	10	6	2	2
<b>Twelve Button Bar Gun</b>				
M4-12460KSN3	12	4	6	2
M4-12550KSN3	12	5	5	2
M4-12640KSN3	12	6	4	2
<b>Fourteen Button Bar Gun</b>				
M4-14660KSN3	14	6	6	2
M4-14750KSN3	14	7	5	2
M4-14840KSN3	14	8	4	2

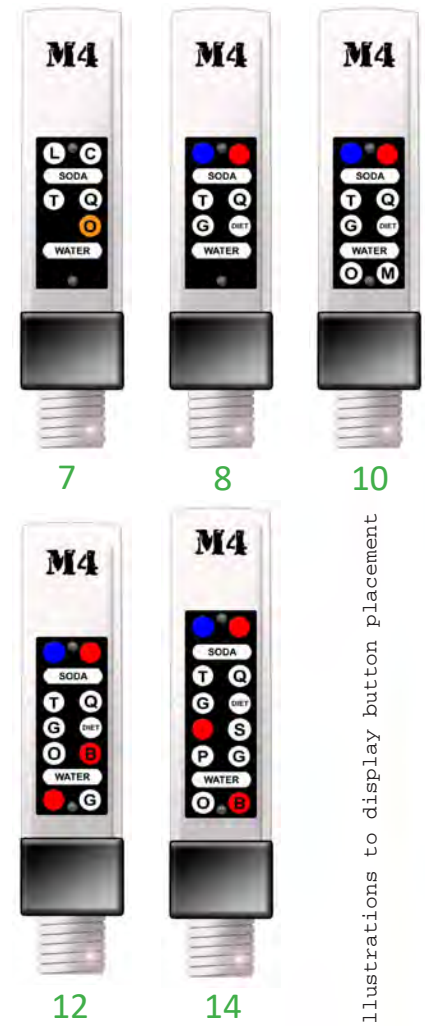

Illustrations to display button placement



- Barguns work with any bag-in-box system.
- 36" stainless steel flexhose with hardened handle casing.
- Additional 48-56-60-72-84 inch flexhose lengths available. Replace the 3 with a 4 to designate 48" hose and so on.
- No Manifold.
- Self-rinsing nozzle cup.
- NSF and ETL sanitation certified.
- Recirculation bargun.
- Fully hydraulic with no electronic parts.

Black Nozzle and Heel



Note: Red and Blue handle models are available (not shown)

## Bar Guns

### Pre-Mix Bar Guns

#### Flexhose Bar Dispensers

Product #	Total # of Buttons	Ice Shield
WB-PMX-5	5	
WB-PMX-7	7	
WB-PMX-5-S	5	✓
WB-PMX-7-S	7	✓

Presently shows active, but these models maybe Obsolete. Call for availability before ordering



### Energy Drink Guns

#### Flexhose Bar Dispensers

GIS #	Product #	Total # of Buttons
WBM-110-II.5	M4-1100KSM3	1
WBM-220-II.5	M4-2200KSM3	2

- For dispensing energy drinks.
- 36" Hose Length.



### Juice Bar Guns

#### Flexhose Bar Dispensers

Product #	Hose	Total # of Buttons
M4-6JDKS3	36"	6
M4-8JDKS3-3/8	36"	8
M4-8JDKS4-3/8	48"	10

- For dispensing juices (non-pulp).
- Standard 36" stainless steel flexhose.
- Available with metering screws only.



Ice Machine Cleaners

# Nickel-Safe Ice Machine Cleaner



Item #	Description	
<b>4287-34</b>	Nickel-Safe Ice Machine Cleaner 16 fl oz.	<b>N/S</b>
<ul style="list-style-type: none"> <li>&gt; Made for use on machines with Nickel-Plated Evaporators.</li> <li>&gt; Can be used on any cuber, flaker, drum, or tube ice maker.</li> <li>&gt; Food-Grade, USDA-Accepted.</li> </ul>		

Item #	Description	
<b>1011411-88</b>	Nickel-Safe Ice Machine Cleaner 16 fl oz.	<i>Stocked</i>
<ul style="list-style-type: none"> <li>&gt; Made for use on machines with Nickel-Plated Evaporators.</li> <li>&gt; Can be used on any cuber, flaker, drum, or tube ice maker.</li> <li>&gt; Food-Grade, USDA-Accepted.</li> </ul>		



# ScaleKleen Deliming/Scale Remover

Item #	Description	
<b>EV9798-35</b>	ScaleKleen Deliming/Scale Remover Cleaner 2.2 lbs.	<i>Stocked</i>
<ul style="list-style-type: none"> <li>&gt; Quickly removes limescale from coffee brewers and similar equipment.</li> <li>&gt; Idea for deliming steam and warewashing equipment.</li> <li>&gt; Non-toxic, safer to skin and won't burn clothing like other deliming acids.</li> <li>&gt; Sewer system disposable, so you can pour it down the drain.</li> <li>&gt; Use with the JT cartridge system to avoid equipment disassembly.</li> <li>&gt; Works on most water using equipment where deliming is required.</li> <li>&gt; Product must be used according to use instructions stated on canister.</li> </ul>		



Item #	Description	
<b>EV9608-00</b>	4JT Flushing/Sanitizing 16" Cartridge	<b>GIS # 9608-00</b>
<b>EV9608-10</b>	2JT Flushing/Sanitizing 10" Cartridge	<b>N/S</b>
<ul style="list-style-type: none"> <li>&gt; For use in existing Everpure quick change filter heads.</li> <li>&gt; For use with ScaleKleen or other sanitizing agents.</li> <li>&gt; Eliminates the need for difficult component disassembly.</li> <li>&gt; Cartridges must be installed and used according to instructions.</li> </ul>		



EV9608-00



EV9608-10

- ➔ Add ScaleKleen or other sanitizing agent.
- ➔ Insert cartridge in an Everpure filter head.

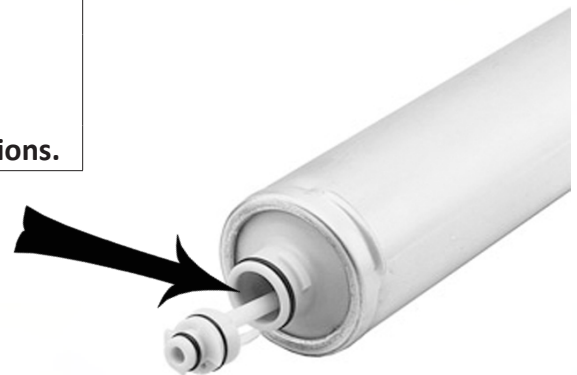

UF-1 and UFB-1 Beverage Valves

**UF-1 Sanitary Lever**  
**Part # 561000126**  
 Flow Rate: 1.5 - 3 oz (JUICE VALVE)



N/S

**UF-1 Sanitary Lever**  
**Part # 561000121**  
 Flow Rate: 1.5 - 3 oz



Stocked

**UF-1 Optifill Lever**  
**Part # 2306**  
 Flow Rate: 1.5 - 3 oz



N/S

**UF-1 Portion Control**  
**Part # 2307**  
 Flow Rate: 1.5 - 3 oz



N/S

**UF-1 Push Button**  
**Part # 2304**  
 Flow Rate: 1.5 - 3 oz



N/S

**UFB-1 Sanitary Lever**  
**Part # 561000156**  
 Flow Rate: 2 - 4 oz



Stocked

**UFB-1 Optifill Lever**  
**Part # 561000165**  
 Flow Rate: 2 - 4 oz



Stocked

**UFB-1 Portion Control**  
**Part # 561000159**  
 Flow Rate: 2 - 4 oz



N/S

**UFB-1 Push Button**  
**Part # 561000162**  
 Flow Rate: 2 - 4 oz



Stocked

N/S = Non-Stocked Item, requires special order and lead time.

SFV-1, LEV, Prism, and Illuminated Beverage Valve

**SFV-1 Sanitary Lever**

Part # **620608761**

Flow Rate: 1.5 - 3 oz



Stocked

**SFV-1 Optifill Lever**

Part # **620608764**

Flow Rate: 1.5 - 3 oz



Stocked

**SFV-1 Portion Control**

Part # **620608763**

Flow Rate: 1.5 - 3 oz



N/S

**SFV-1 Push Button**

Part # **620608762**

Flow Rate: 1.5 - 3 oz



N/S

**LEV Sanitary Lever**

Part # **19-0120**

Flow Rate: 1.5 - 3 oz



Stocked

**LEV Push Button**

Part # **19-0114**

Flow Rate: 2 - 4 oz



Stocked

**Prism Sanitary Lever**

Part # **620073003**

Flow Rate: 1.5 - 3 oz



Black

\*, \*\*, N/S

**Prism Push Button**

Part # **620073005**

Flow Rate: 1.5 - 3 oz



Black

\*, \*\*, N/S

**Illuminated UFB Valve**

Part # **620070513**

Flow Rate: 2 - 4 oz



N/S

N/S = Non-Stocked Item, requires special order and lead time.

\*\* Note: Prism valve is only available for Soft-Plumbed units

\* Prism valve installation may require adapter plates and knockout punch kit (ask a salesperson for part numbers).

Specialized Beverage Valve



# TOUCHLESS

## Touchless Beverage & Ice Dispensing

An Innovative Hands Free Sanitary Solution

In today's foodservice environment, reducing the number of consumer touchpoints is top of mind and challenges current foodservice self-serve stations. The Touchless Beverage & Ice Dispensing solution keeps consumers safe by reducing the risk of surface contact.

- **Cup Sensing Technology** - Place a cup below the valve to activate product dispense. Remove cup to deactivate the sensor.
- **LED Dispensing Indicators** - The valve provides a visual dispensing cue using LED lights for both beverage and ice.
- **Easy to Clean** - Provides a primary key switch for fast and easy cleaning and defaults back to normal dispense mode after 60 seconds.
- **Accommodates All Ice and Cup Types/Sizes** - Up to 52 oz, excluding glass.
- **Easy to Control** - Enhanced pour features allow for faster response times, top-off capabilities, and auto shut-off.
- **Upgrade Existing Equipment to Touchless** - Upgrade or replace existing SFV1, UFB, or UF1 valves with no rebricking.



629097984



Black



629097982



629097980

Part #	Description	
629097984	Touchless Valve Conversion Kit	N/S
629097982	Touchless Ice Kit, Single Ice Chute, ED1-2XX	N/S
629097980	Touchless Ice Kit, Double Ice Chute, ED300	N/S

N/S = Non-Stocked Item, requires special order and lead time.



# 1 Box Shelf

- Sturdy all welded construction (Powder Coated Black).
- Modular design to fit your needs.
- Large oblong holes built into each shelf to run BIB tubing from back.
- Flat or Inclined shelves packaged in a box of four with connectors.
- Flat or Inclined shelves can be purchased individually if needed.
- 60 Lb weight capacity.



with hole panels

PART #

<b>1-BFFJ</b>	<b>1 Box Flat Shelf</b>
15" W x 17" D x 11" H	

Use connectors to stack shelves.

Stocked



with glide panels

PART #

<b>1-BIFJ</b>	<b>1 Box Inclined</b>
15" W x 17" D x 11" H	

Use connectors to stack shelves.

Stocked

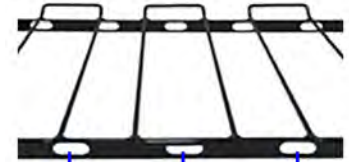

Large oblong holes built into each shelf to run BIB tubing from back

## Top Shelf



with hole panels

PART #

<b>1-BTSFJ</b>	<b>1 Box Top Shelf with hole panels</b>
15" W x 17" D x 8.5" H	

Use plastic connectors to stack shelf.

N/S



Hole panel



glide panel

## Top Pump Mount

with glide panels

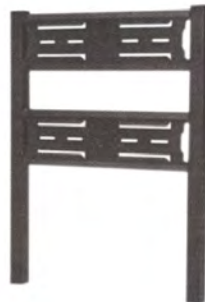

PART #

<b>1-BPM4FJG</b>	<b>1 Box Top Pump Mount for 4 Pumps</b>
15" W x 1" D x 12" H	

Stocked



N/S = Non-Stocked Item, requires special order and lead time.

# 2 Box Shelf

- Sturdy all welded construction (Powder Coated Black).
- Modular design to fit your needs.
- Large oblong holes built into each shelf to run BIB tubing from back.
- Flat Vertical or Inclined shelves packaged in a box of four with connectors.
- Flat Vertical or Inclined shelves can be purchased individually if needed.
- 120-150 Lb weight capacity.

with glide panels

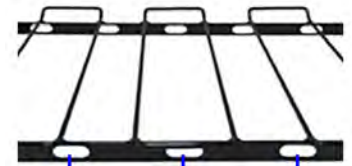

Large oblong holes built into each shelf to run BIB tubing from back

with glide panels

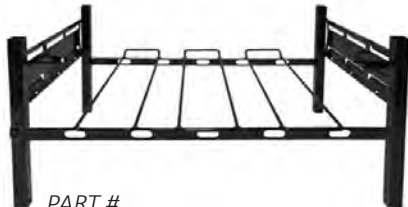

PART #

<b>2-BVFFJ</b>	2 Box Flat Vertical
28" W x 17" D x 14" H	

Use plastic connectors to stack shelves.

N/S

with glide panels

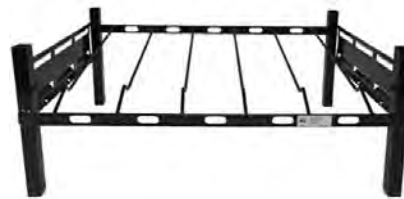

PART #

<b>2-BIFJ</b>	2 Box Inclined
28" W x 17" D x 12" H	

Use plastic connectors to stack shelves.

N/S

## Top Shelf



with glide panels



glide panel

PART #

<b>C2-BTSFJ</b>	2 Box Top Shelf with glide panels
28" W x 17" D x 9" H	

Use plastic connectors to stack shelf.

N/S

## Top Pump Mount



with glide panels



PART #

<b>2-BPM6FJG</b>	2 Box Top Pump Mount for 6 Pumps
27" W x 1" D x 24" H	

N/S

N/S = Non-Stocked Item, requires special order and lead time.



# 3 Box Shelf

- Sturdy all welded construction (Powder Coated Black).
- Modular design to fit your needs.
- Large oblong holes built into each shelf to run BIB tubing from back.
- Flat Vertical or Inclined shelves packaged in a box of four with connectors.
- Flat Vertical or Inclined shelves can be purchased individually if needed.
- 180 Lb weight capacity.

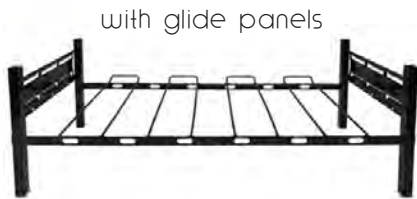

PART #

<b>3-BVFFJ</b>	3 Box Flat Vertical
39" W x 17" D x 14" H	

Use plastic connectors to stack shelves.

Stocked

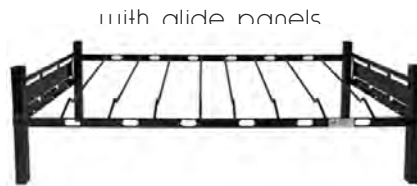

PART #

<b>3-BIFJ</b>	3 Box Inclined
39" W x 17" D x 12" H	

Use plastic connectors to stack shelves.

N/S

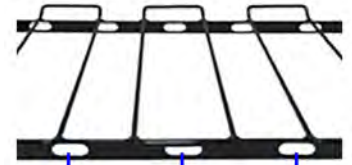

Large oblong holes built into each shelf to run BIB tubing from back

## Top Shelf



glide panel

PART #

<b>3-BTFJ</b>	3 Box Top Shelf with glide panels
39" W x 17" D x 8.5" H	

Use plastic connectors to stack shelf.

N/S

## Top Pump Mount



PART #

<b>3-BPM8FJG</b>	3 Box Top Pump Mount for 8 Pumps
39" W x 1" D x 24" H	

Stocked



PART #

<b>3-CPMFJG</b>	Center Pump Mount
39" W x 17" D x 15.5" H	

Use plastic connectors to stack shelves.

Stocked

N/S = Non-Stocked Item, requires special order and lead time.

# BIB FLEX RACK SYSTEM w/ RISER

## Part # 44239-POWDER

28" BIB 2-Shelf, 3W X 2H

- Sturdy all welded construction.
- Powder coated grey.
- Two flat shelves, 3 wide x 2 high.
- 28" width.
- Pump riser included.
- Plastic feet and caps included.
- Rack can be stacked using rack connectors.
- Pre-packaged, ready to assemble.



Side View

Each rack shelf provides storage for up to three (3) Bag-In-Box (BIB)

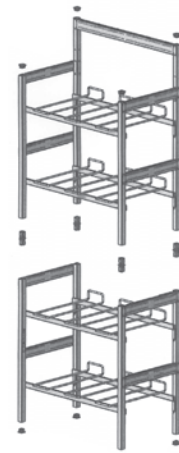

Stackable  
(connectors not included)

In stock, ready to ship!



Exclusive

Bag-In-Box Rack Systems

# Pre-built Bag-in-Box Rack Systems

For backroom application

**Pump Master  
Guaranteed**



Part #	Description
<b>BIB-10010</b>	6 Product w/ Riser
<b>BIB-10013</b>	8 Product w/ Riser
<b>BIB-10022</b>	10 Product w/ Riser

Part #	Description
<b>BIB.10014</b>	8 Product
<b>BIB.10080</b>	12 Product
<b>BIB.10090S</b>	16 Product w/ Top
<b>BIB.10092S</b>	20 Product w/ Top
<b>BIB.10093S</b>	24 Product w/ Top



- Sturdy all welded construction.
- Powder coated black rack.
- All rack systems are custom built to specification.
- All BIB pumps, tubing, and connectors included.
- CO2 regulator(s) included.
- **Great for backrooms, convenience stores, and restaurants.**

Part #	Description
<b>BIB.10090</b>	16 Product w/ Halo Pump Configuration
<b>BIB.10092</b>	20 Product w/ Halo Pump Configuration
<b>BIB.10093</b>	24 Product w/ Halo Pump Configuration

Assembled by our Pump Master to the customer's specification and need. Once complete, the assembly is strapped and wrapped to pallet(s) and then shipped by freight carrier.

Bag-In-Box Rack Systems

Pump Master  
Guaranteed

**BUILD TO ORDER  
TEA OR JUICE  
BAG-IN-BOX DISPENSING SYSTEM**

- Sturdy all welded construction.
- Powder coated black rack.
- Custom built configurations to specification.
- Required BIB pumps, tubing, and connectors included.
- Required CO2 regulator(s) included.
- Includes mounted bargun.
- Pre-assembled and shipped complete.
- **Great for nursing stations and health care facilities.**



Because these systems are custom built, there are no specific part numbers available. When ordering, provide details of type tea and/or juice system you require and the sales person will configure the system to your specifications and provide a quote thereafter.

**Pre-built 4-Pump Bag-in-Box Rack System**

Flat Vertical Shelves with Pump Panel Riser

For use with Frozen Carbonated Beverage (FCB) machine or other related equipment



- Sturdy all welded construction.
- Powder coated black rack.
- Can also be custom built to specification.
- All BIB pumps, tubing, and standard connectors included.
- CO2 regulator included.
- Pre-assembled to specification and disassembled for shipping.
- **Designed for use with 4-Product FCB machines.**



**Part # BIB-10004**

- 15" wide x 17" deep x 69" high.
- Top box height 45".
- Modular design.
- Syrup lines feed through back of rack.



Each pre-built BIB rack comes with standard gray BIB connectors. If you require Pepsi or Coke connectors (green or red), please advise at time of order.

# Bag-in-Box Rack Systems and Backroom Packages

Whether its Convenience Stores, Restaurants, Fast Food Chains, Hospitals, or Hotels, we are experts at providing complete Ice, Beverage, and backroom packages to serve every need.

Flat Vertical with Louvered Pump Panel racks specially designed to hold 4 BIB boxes per shelf.



Large center holes built into each shelf to run BIB tubing from the back.

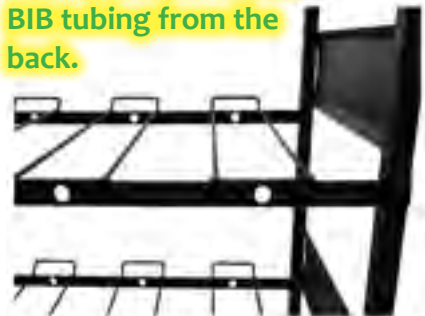

Primary and secondary regulators mounted to rack for easy connection to system.



Side panels on each shelf provides pump mounting holes to add additional BIB pumps as necessary.



From inception Gulf Ice Systems has been an innovator providing beverage dispensing solutions. From the original concept of bundled beverage tubing to the BIB Halo system configuration, we've been instrumental in historically impacting the industry.

Bag-In-Box Rack Systems



Person 6'0"

The Bag-in-Box rack system depicted on the left is configured for 20 Flojet pumps per section (Halo configuration with a total of 40 pumps)



Person 4'10"

An individual measuring 4'10" in height is still capable of reaching the top shelf to insert a 5-gallon BIB box.

This BIB rack configuration holds up to (40) 5-gallon BIB Boxes.

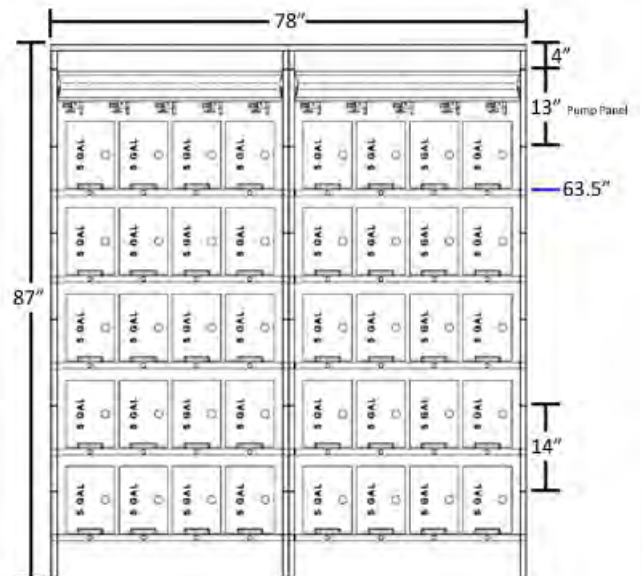

Bag-In-Box Air Pumping Station

This is an economical air station for use with BIB pumps. It features a piston style compressor and a stainless steel tank. The air pumping station can operate up to 3 pumps simultaneously.

The automatic pressure switch is preset for 60 psi on and 80 psi off. All models have quick disconnect with a 1/3 HP compressor. Each model has a pressure regulator with gauge and a self-draining condensation valve. Both models are 115 VAC.



99-2201

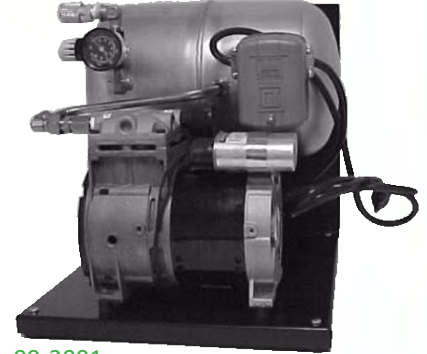

99-2001

Product #    *Discription*

**Bag-In-Box Air Pumping Station**

<b>99-2201</b>	Single BIB Air Pumping Station for Wall Mounting	Stocked
<b>99-2001</b>	Single BIB Air Pumping Station for Floor Mounting	Stocked



**ECONOMY WATER BOOSTERS**

- Provides a continuous flow of water.
- Schrader connection for easy tank pressure check.
- Controls city water pressure fluctuations.
- Can also be custom built to specification.
- Designed for table or wall mounting.
- 150 psi pressure relief valve.
- Durable aquatec motor/pump combo.
- All stainless steel fittings.
- Voltage is 115 VAC.



*McCann's*

Product #    *Discription*

Inlet	Outlet	Total Reserve	Pressure	
-------	--------	---------------	----------	--

**Economy Water Boosters**

<b>16-3172</b>	2-gallon Stainless Steel tank	3/8"	3/8"	93 oz.	150 psi	Stocked
<b>16-3174</b>	4-gallon Stainless Steel tank	1/2"	1/2"	222 oz	150 psi	Stocked



16-3172

11 7/8" w x 15 5/8" d x 9" h



16-3174

15" w x 17 7/8" d x 12" h

<b>MINI Water Booster</b>
<b>Item # 804-001</b>
115V / 60 PSI / 21 Oz Tank
INLET / OUTLET: 1/4" & 3/8" barb

N/S

<b>MINI Water Booster</b>
<b>Item # 804-002</b>
115V / 90 PSI / 21 Oz Tank
INLET / OUTLET: 3/8" barb

N/S

<b>MINI Water Booster</b>
<b>Item # 804-042</b>
240V / 90 PSI / 21 Oz Tank
INLET / OUTLET: 3/8" barb

N/S

<b>Medium Water Booster</b>
<b>Item # 804-023</b>
115V / 90 PSI / 2 gal Tank
INLET / OUTLET: 3/8" barb

N/S

<b>Medium Water Booster</b>
<b>Item # 804-066</b>
115V / 60 PSI / 2 gal Tank
INLET / OUTLET: 3/8" barb

N/S

<b>Medium Water Booster</b>
<b>Item # 804-034</b>
240V / 90 PSI / 2 gal Tank
INLET / OUTLET: 3/8" barb

N/S

<b>MAXI Water Boost System</b>
<b>Item # 804-037</b>
115V / 90 PSI / 6 gal Tank
INLET / OUTLET: 3/8" barb

N/S

<b>MAXI Water Boost System</b>
<b>Item # 804-026</b>
115V / 90 PSI / 6 gal Tank
INLET / OUTLET: 1/2" barb

N/S

<b>MAXI Water Boost System</b>
<b>Item # 804-067</b>
240V / 90 PSI / 6 gal Tank
INLET / OUTLET: 3/4" NPT

N/S

<b>MAXI Water Boost System</b>
<b>Item # 804-068</b>
240V / 90 PSI / 6 gal Tank
INLET / OUTLET: 1/2" barb

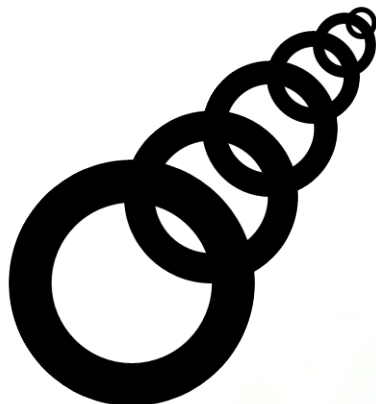
N/S





# Installation Kits POST-MIX

## T5000 Series Kits

			T5000 SERIES			
		Kit Part Number →	GIS/CCE-PTK-6	GIS/CCE-PTK-8	GIS/CCE-PTK-10	GIS/CCE-PTK-12
Manufacturer	Manufacturer Part Number	Item Description	6 Valve Unit or 8 Button BG	8 Valve Unit or 10 Button BG	10 Valve Unit or 12 Button BG	12 Valve Unit or 14 Button BG
Flojet	T5000-830A	3 BIB Pump Kit	2	2	2	4
Flojet	T5000-820A	2 BIB Pump Kit		1	2	
Taprite	C77002	CO2 Management System	1	1	1	1
McCanns	E400397	Carbonator w/ Vented Check Valve	1	1	1	1
Flojet	01750-302	Water Pressure Regulator (50 PSI)	1	1	1	1
Taprite	RC-1	CO2 Tank Restraint	1	1	1	1
		Packaging	1	1	1	1

Comes with RED BIB connectors by default.

For kits less H2O Regulator add -E at end of part #



GIS/CCE-PTK-6



GIS/CCE-PTK-8



GIS/CCE-PTK-10



GIS/CCE-PTK-12

## G55 Series Kits (High Flow)

Minus Water Regulator			G55 SERIES			
		Kit Part Number →	GIS/CCE-PTK-6HF-E	GIS/CCE-PTK-8HF-E	GIS/CCE-PTK-10HF-E	GIS/CCE-PTK-12HF-E
Manufacturer	Manufacturer Part Number	Item Description	6 Valve Unit or 8 Button BG	8 Valve Unit or 10 Button BG	10 Valve Unit or 12 Button BG	12 Valve Unit or 14 Button BG
Flojet	G55-3CCE	3 BIB Pump Kit	2	2	2	4
Flojet	G55-2CCE	2 BIB Pump Kit		1	2	
Taprite	C77002	CO2 Management System	1	1	1	1
McCanns	E400397	Carbonator w/ Vented Check Valve	1	1	1	1
Taprite	RC-1	CO2 Tank Restraint	1	1	1	1
		Packaging	1	1	1	1



GIS/CCE-PTK-6HF-E



GIS/CCE-PTK-8HF-E



GIS/CCE-PTK-10HF-E



GIS/CCE-PTK-12HF-E

Comes with RED BIB connectors by default. If you require green or grey connectors, please advise at time of order.

See page 102 for BIB Connector options

# Installation Kits

## PRE-MIX & TEA

### Pre-Mix Install Kit

		Kit Part Number →	GIS/CCE-PRK-6
Manufacturer	Manufacturer Part Number	Item Description	6 Product
Taprite	3756-01	Regulator, 2 Pressure, 6 Product	1
Taprite	RC-1	CO2 Tank Restraint	1
Taprite	440-18	Regulator Wrench	1
		Packaging	1



GIS/CCE-PRK-6

**Pump Master  
Guaranteed**

### Tea Install Kits

		Kit Part Number →	GIS/CCE-TK2	GIS/CCE-TK4
Manufacturer	Manufacturer Part Number	Item Description	2 Valve Kit	4 Valve Kit
Flojet	T5000-840A	3 BIB Pump Kit		1
Flojet	T5000-820A	2 BIB Pump Kit	1	
Everpure	EV9259-24	QL3B Filter Head	1	1
Everpure	EV9618-11	7CB5 Filter Cartridge	1	1
		Packaging	1	1



GIS/CCE-TK2



GIS/CCE-TK4



Each kit comes with RED BIB connectors by default. If you require Pepsi or Generic connectors (green or Gray) instead of Coca-Cola (red), please advise at time of order.

See page 102 for BIB Connector options

**QCD-II BIB Connector  
Generic, Gray**

**Part # CPA-02**

Liqui-Box Oem # CC-QCDII



Stocked

**Red BIB Hose Connector  
3/8" Barbed**

**Part # 82-0291**

Coca-Cola BIB Connector



Stocked

**Green Encore BIB  
Connector, Screw-on**

**Part # 33230**

Pepsi-Cola BIB Connector



Stocked

**Maroon BIB Connector**

**Part # 122775**

Dr. Pepper BIB Connector



Stocked

**Juice BIB Connector  
Generic, Gray**

**Part # CPA-3**

Liqui-Box OEM # CPA-3



Stocked

**PCSS BIB Connector  
New Style, Screw-on**

**Part # 0505015-01A**



Stocked

**PCS BIB Connector  
Old Style, Snap-on**

**Part # 0505009-01A**



Stocked

**Scholle BIB Connector  
3/8" (L), Black**

**Part # 202004**



Stocked

**Red Sanitizer Flush  
Adapter, 3/8" Barbed**

**Part # 20-1110-20**

Coca-Cola



N/S

N/S = Non-Stocked Item, requires special order and lead time.

<b>QCD BIB Sanitizing Adapter, Liqui-Box</b>
<b>Part # QCIP</b>
For QCD2 BIB Connections

Stocked

<b>Green Encore BIB Sanitizing Adapter</b>
<b>Part # 33085</b>
Liqui-Box / Lancer

Stocked

<b>Figal BIB Adapter Plastic</b>
<b>Part # 05-0249</b>

N/S

<b>Figal BIB Adapter Kit GAL X BIB, PHS III</b>
<b>Part # 81-0029</b>
(3) Adapters / (3) Depressurizers

N/S

<b>BIB Beverage Tubing, Clear 3.8" ID x 5/8" OD, 100'</b>
<b>Part # 200-0610X100</b>
100' Payout Carton

Stocked

<b>BIB Beverage Tubing, Clear 3.8" ID x 5/8" OD, 500'</b>
<b>Part # 200-0610X500</b>
500' Boxed Spool

N/S

N/S = Non-Stocked Item, requires special order and lead time.

# BIB Syrup Beverage Pump Kits

## POST-MIX

### FLOJET G55 High Capacity Pump Kits *w/ CO2 Manifold*



G55-1CCE



G55-2CCE



G55-3CCE

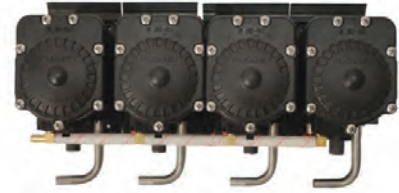

G55-4CCE

### FLOJET T5000 Pump Kits *w/ CO2 Manifold*



(No Manifold)

T5000-502



T5000-820A



T5000-830A



T5000-840A

OEM # T5200810  
GIS # 5000-502

OEM # T5200821  
GIS # N5000-820A

OEM # T5200831  
GIS # N5000-830A

OEM # T5200841  
GIS # N5000-840A

Comes with RED BIB connectors by default. If you require green or gray connectors, please advise at time of order.

[See page 102 for BIB Connector options](#)

## Electric Powered Syrup Pump

For pumping BIB Syrup from Bag-in-Box to Dispenser

- Pump Design: Double Diaphragm.
- Self-Priming up to 6-feet (1.8m).
- Runs dry without damage.
- Ports: 1/4" NPT, female.
- NSF standard 18 UL listed.
- Voltage: 115v / 60 hz.



Electric BIB Flojet Syrup Pump

GIS # **2125-030**

OEM # **02125030A**

Stocked

# FLOJET

Bag-In-Box Syrup Pumps

# CO2 Gas, Nitrogen, or Compressed Air Powered Pumps

For pumping BIB Syrup from Bag-in-Box to Dispenser



T5000 Series Flojet Syrup Pump	
<b>GIS # 5000-140</b>	
<b>OEM # T5000110</b>	
Older # N5000-140 and T5000-140	
<b>INLET:</b> Barbed Straight Plastic:	3/8"
<b>OUTLET:</b> Barbed Straight SS:	1/4"
<b>GAS IN:</b> w/ CO2 Shutoff: Brass Straight:	1/4"
Stocked	



T5000 Series Flojet Syrup Pump	
<b>GIS # 5000-515</b>	
<b>OEM # T5000111</b>	
Older # N5000-515 and T5000-515	
<b>INLET:</b> Barbed Straight Plastic:	3/8"
<b>OUTLET:</b> Barbed Straight SS:	3/8"
<b>GAS IN:</b> w/ CO2 Shutoff: Brass Straight:	1/4"
Stocked	



T5000 Series Flojet Syrup Pump	
<b>GIS # 5000-130</b>	
<b>OEM # T5000114</b>	
Older # N5000-130 and T5000-130	
<b>INLET:</b> Barbed Straight Plastic:	3/8"
<b>OUTLET:</b> Barbed Straight Plastic:	3/8"
<b>GAS IN:</b> w/ CO2 Shutoff: Straight Plastic:	1/4"
N/S	



T5000 Series Flojet Syrup Pump	
<b>GIS # 5000-509</b>	
<b>OEM # T5000810</b>	
Older # N5000-509 and T5000-509	
<b>INLET:</b> Barbed Straight Plastic:	3/8"
<b>OUTLET:</b> Barbed Straight SS:	1/4"
<b>GAS IN:</b> w/ CO2 Shutoff: Brass Straight:	1/4"
N/S	



T5000 Series Flojet Syrup Pump	
<b>GIS # N5000-146</b>	
<b>OEM # T5030110</b>	
Older # N5000-146 and T5000-146	
<b>INLET:</b> Barbed Straight Plastic:	3/8"
<b>OUTLET:</b> Barbed Straight SS:	1/4"
<b>GAS IN:</b> w/ CO2 Shutoff: Brass Elbow:	1/4"
N/S	



T5000 Series Flojet Syrup Pump	
<b>GIS # N5000-158</b>	
<b>OEM # T5030111</b>	
Older # N5000-158 and T5000-158	
<b>INLET:</b> Barbed Straight Plastic:	3/8"
<b>OUTLET:</b> Barbed Straight SS:	3/8"
<b>GAS IN:</b> w/ CO2 Shutoff: Brass Elbow:	1/4"
Stocked	



T5000 Series Flojet Syrup Pump	
<b>GIS # 5000-135</b>	
<b>OEM # T5190119</b>	
Older # N5000-135 and T5000-135	
<b>INLET:</b> No fitting:	
<b>OUTLET:</b> No fitting:	
<b>GAS IN:</b> No CO2 Shutoff:	
Stocked	



- Designed for dispensing BIB syrups.
- Juice concentrate (without pulp or particulates).
- Can dispense teas, wines, draft beer, and liquor.
- Compact design with quick disconnect fittings.

N/S = Non-Stocked Item, requires special order and lead time.

Bag-In-Box Syrup Pumps

# CO2 Gas, Nitrogen, or Compressed Air Powered Pumps

For pumping BIB Syrup from Bag-in-Box to Dispenser

## FLOJET



- Designed for dispensing BIB syrups.
- Juice concentrate (without pulp or particulates).
- Compact design with quick disconnect fittings.

Product #      *Discription*

### G55 Series Single Syrup Pump

		Inlet	Outlet	Gas In	
		Barbed Straight Stainless Steel	Barbed Straight Stainless Steel	CO2 Shutoff	
<b>G55-1012</b>	Single Pump w/ auto shutoff valve	3/8"	1/4"	1/4" Brass Straight	N/S
<b>G55-1022</b>	Single Pump w/ auto shutoff valve	3/8"	3/8"	1/4" Brass Straight	Stocked
<b>G55-1000M</b>	Single Pump, no fittings	--	--	--	N/S

Other models with multiple configurations available for specific applications. Not all single pump options are listed here.



- Designed for dispensing juice concentrate with pulp.
- Designed for dispensing condiments which have pulp.
- Can dispense highly viscous particulates.

Product #      *Discription*

### G58 Series Single Pulpjet Pump

		Inlet	Outlet	Gas In	
		Barbed Straight Stainless Steel	Barbed Straight Stainless Steel	CO2 Shutoff	
<b>G80-1022</b>	Single Pump w/ auto shutoff valve	3/8"	3/8"	1/4" Brass Straight	Stocked



- Designed for dispensing beer from keg, cask, or brew kettle.

- > An Air compressor can be used to pressurize the beer pump.
- > One pump will feed up to three faucets through a single line.
- > It can be used for both long or short draw systems.

Product #      *Discription*

### G56 Series Single Beer Pump

		Inlet	Outlet	Gas In	
		Barbed Straight Plastic	Barbed Plastic	CO2 Shutoff	
<b>G56-1202</b>	Single Beer Pump	3/8"	3/8" Straight	1/4" Brass Straight	Stocked

Part #	Description	
FRV0001	Reverse Flow Valve for G56 Beer Pumps Only	N/S



Allows running cleaning solution both directions and through multiple lines at one time.

N/S = Non-Stocked Item, requires special order and lead time.



Bag-In-Box Syrup Pumps

# CO2 Gas, Nitrogen, or Compressed Air Powered Pumps

For pumping BIB Syrup from Bag-in-Box to Dispenser

## SHURflo



- Designed for dispensing BIB syrups.
- Juice concentrate (without pulp or particulates).
- Can dispense teas, wines, milk, and water.
- Compact design with quick disconnect fittings.
- Features automatic demand and sold-out shutoff.
- Max operating pressure is 85 psi.
- Includes metal mounting bracket.

Product #      Description

### Heavy Duty Advantage Single Syrup Pump

Product #	Description	Inlet	Outlet	Gas In	Stocked
94-360-38	Single Pump (black) BIB Syrup	3/8"	3/8"	1/4" Plastic Elbow	

Inlet	Outlet	Gas In
Barbed Elbow Plastic	Barbed Elbow Stainless Steel	CO2 Shutoff

Other models with multiple configurations available for specific applications. Not all single pump options are listed here.



- Designed for dispensing juice concentrate with pulp.
- Designed for dispensing condiments which have pulp.
- Can dispense highly viscous particulates.
- Max operating pressure is 70 psi.
- Includes metal mounting bracket.

Product #      Description

### Heavy Duty Advantage Single Juice Pump

Product #	Description	Inlet	Outlet	Gas In	Stocked
94-360-05	Single Pump BIB Juice	3/8"	3/8"	1/4" Brass Elbow	

Inlet	Outlet	Gas In
Barbed Elbow Plastic	Barbed Elbow Plastic	CO2 Shutoff

## Brix Pumps



- Designed as a proportioning device to pump two liquids (water and concentrate) in an exact ration.
- The ration is determined by the pump design.
- No brix adjustments are ever needed.
- Ideally suited to juice applications and incorporates a valve for use with syrups containing "stringy" pulp.
- Includes metal mounting bracket.

Product #      Description

### Brix Single Pump

Product #	Description	Ratio	Stocked
94-260-01	Single Brix Pump w/ vacuum shutoff	3 : 1	N/S
94-260-03	Single Brix Pump w/ vacuum shutoff	4 : 1	N/S
94-260-05	Single Brix Pump w/ vacuum shutoff	5 : 1	Stocked

#### Available Fittings:

Standard configuration is 3/8" barbed plastic elbow.

1/4", 3/8", and 1/2" barbed, plastic, or stainless steel, straight and/or elbow are available if requested at time of order.



N/S = Non-Stocked Item, requires special order and lead time.



# SHURflo

## Automatic Selector Valves (ASV)

The Shurflo ASV permits two or more syrups (BIBs) to be connected at the inlet port of the BIB pump. The BIB pump draws product through one side of the ASV until the BIB is evacuated and higher than normal vacuum is detected. Once the “switching” level of vacuum is obtained, the ASV automatically switches and begins drawing product from the BIB connected to the other side. The ASV permits uninterrupted drink dispensing and allows store personnel the ability to replace the BIBs at a convenient time.

Automatic Selector Valve	Automatic Selector Valve	Automatic Selector Valve
<b>Item # 94-350-08</b>	<b>Item # 94-350-03</b>	<b>Item # 165-110</b>
18.0 in. Hg. Switch Point	18.0 in. Hg. Switch Point	12.0 in. Hg. Switch Point
3/8" barb fittings 	3/8" barb fittings ELBOW on OUTLET 	3/8" barb fittings HIGH ALTITUDE 
<b>GIS # 165-000 (N/S)</b>	<b>N/S</b>	<b>N/S</b>

N/S = Non-Stocked Item, requires special order and lead time.



# Palm Abbe Digital Refractometer

For Brixing Fountain & Juice Beverages

## Model: PA201

### Digital Refractometer

Comes with rubber armor jacket and heavy duty Carry Case



*Includes Carry Case & jacket*



- Designed for use with FCB machines.
- Determines sugar content in juice & fountain beverages
- Range 0 to 56 Brix
- Resolution 0.1%
- Precision +/-0.1%
- Price includes rubber armor jacket
- Price includes rugged carry case
- Features Sapphire Optics
- Features Stainless Steel Well
- Features Evaporation Cover
- 24 Character Display with Backlight
- 1,024 Element Detector Array
- Powered by (2) AAA Batteries (included)
- MADE IN THE USA

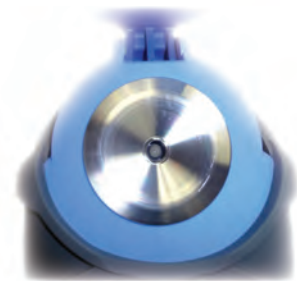

*Sapphire Optics & Stainless Steel Well*

BIB Pump Accessories

**Metal Bracket, 2-Pump**  
**Part # 11028-509**  
 For T5000 Series Pumps



N/S

**Metal Bracket, 3-Pump**  
**Part # 11028-508**  
 For T5000 Series Pumps



N/S

**Slide Track Bracket**  
**Part # 20272-002B**  
 For T5000 Series Pumps



N/S

**Universal Bracket**  
**Part # 20982-100A**  
 Flojet & Shurflo Pumps



Stocked (GIS # 20982-100)

**90 Degree Slide Bracket**  
**Part # 21000-563**  
 For T5000 Series Pumps



Stocked

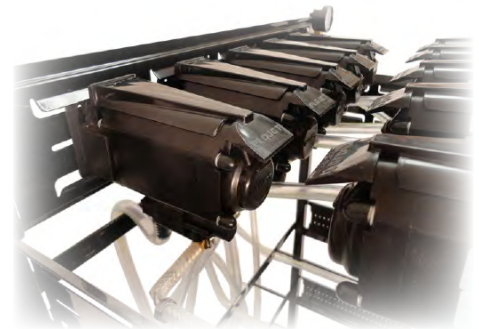

Example of 90 degree bracket application

**8 Pump Mounting Bracket**  
**Part # 21000-325A**  
 For G Series Pumps



Stocked (GIS # 21000325)



**Auto Shutoff Valve**  
**Part # 20308-130**  
 For T5000 Series Pumps



Stocked

**Transfer Valve Bracket**  
**Part # 21000-255B**  
 For Transfer Valves



Stocked (GIS # 21000255B)

**Transfer Valve**  
**Part # 01600230A**  
 For BIB Bag Switching



Stocked (GIS # 1500-030)

**Transfer Valve**  
**Part # 01600530A**  
 For BIB Bag Switching



N/S (GIS # 1500-130)

N/S = Non-Stocked Item, requires special order and lead time.

BIB Pump Fittings

**FLOJET**

GIS Item #	Description
------------	-------------

**LIQUID, Inlet and Outlet Stainless Steel Fittings**

For use with T5000, G55, G58, G5A series gas pumps

20324-030	1/4" Hose Barb, Straight
20325-030	3/8" Hose Barb, Straight
20606-100	1/2" Hose Barb, Straight
20607-100	1/4" Hose Barb, Elbow
20608-100	3/8" Hose Barb, Elbow

For use with G56, K56 series gas pumps

21000-131A	1/4" Hose Barb, Straight
21000-130A	3/8" Hose Barb, Straight

Stainless Steel



**LIQUID, Inlet and Outlet Plastic Fittings**

For use with T5000, G55, and G58 series gas pumps

20325-031	3/8" Hose Barb, Straight
-----------	--------------------------

For use with G56, K56 series gas pumps

20381-026	3/8" - 1/2" Hose Barb, Straight
20381-002	1/2" Hose Barb, Straight
20381-024	3/8" - 1/2" Hose Barb, Elbow
20381-009	1/2" Hose Barb, Elbow

Plastic

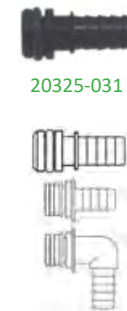

**CO2 / Air Inlet, Plastic**

For use with all T5000 and G series gas pumps

20325-033	1/4" Hose Barb, Straight
-----------	--------------------------



**CO2 / Air Inlet with Shutoff Valve, Brass**

For use with all T5000 and G series gas pumps

1510-000	1/4" Hose Barb, Straight
1520-000	1/4" Hose Barb, Tee
1521-000	1/4" Hose Barb, Elbow
01522-000	1/4" Offset Hose Barb, Tee
01523-000	1/4" Offset Hose Barb, Elbow, Left Hand
01524-000	1/4" Offset Hose Barb, Elbow, Right Hand

Brass



GIS Item #	Description
------------	-------------

**LIQUID, Inlet and Outlet Stainless Steel Fittings**

For use with Shurflo BIB gas pumps

94-178-07	1/4" Hose Barb, Elbow
94-178-18	3/8" Hose Barb, Elbow
94-178-19	3/8" Hose Barb, Straight
94-178-51	1/2" Hose Barb, Elbow
94-178-27	1/2" Hose Barb, Straight

**Stainless Steel**



**LIQUID, Inlet and Outlet Plastic Fittings**

For use with Shurflo BIB gas pumps

94-178-01	3/8" Hose Barb, Elbow
94-178-26	3/8" Hose Barb, Polypro, Elbow (Juice)
94-178-03	3/8" Hose Barb, Straight
94-178-24	3/8" John Guest Adaptor
94-178-20	1/2" Hose Barb, Elbow (Brix pump)
94-178-25	1/2" Hose Barb, Straight (Brix pump)

**Plastic**



**Gas Fittings**

For use with Shurflo BIB gas pumps

94-178-16	1/4" Yellow Barb, Elbow w/ Check Valve
94-178-17	1/4" Yellow Barb, Tee w/ Check Valve
94-178-22	1/4" Brass Barb, Elbow w/ Check Valve
94-178-23	1/4" Brass Barb, Tee w/ Check Valve
94-178-05	1/4" Plastic Barb, Straight, No Check Valve
94-178-02	1/4" Plastic Barb, Elbow, No Check Valve
94-057-00	Muffler Kit (Silencer to fit exhaust port)

**Brass or Plastic**









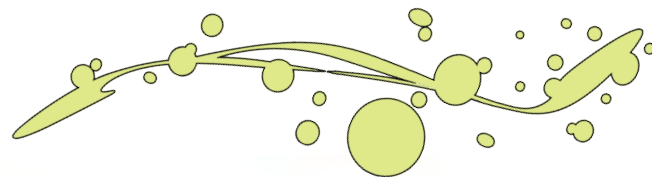













**Quick Disconnect Clips**

For use with Shurflo BIB gas pumps

94-359-10	Small Clip
94-359-50	Large Clip

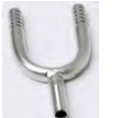

## Beverage Fittings

GIS Item #	Vendor #	Description	
<b>SWIVEL, NUT</b>			
77-0101-00	1001	Nut, 1/4" swivel, nickel plated brass	
77-0301-00	1003	Nut, 3/8" swivel, nickel plated brass	
			77-0101-00 77-0301-00
<b>SWIVEL, STEM</b>			
77-0104-00	3006	Stem, 1/4" swivel hose stem, for 1/4" swivel nut	
77-0304-00	3008	Stem, 1/4" swivel hose stem, for 3/8" swivel nut	
77-0305-00	3009	Stem, 3/8" swivel hose stem, for 3/8" swivel nut	
			77-0104-00 77-0304-00 77-0305-00
<b>SWIVEL, STRAIGHT</b>			
77-0465-00	7058	Flare Nut, 1/4" to 3/8" ID barbed hose straight	
			77-0465-00
<b>SWIVEL, ELBOW</b>			
77-0401-00	7013	Flare Nut, 1/4" x 1/4" ID barbed hose elbow	
7073	7073	Flare Nut, 1/4" x 3/8" ID barbed hose elbow	
77-0409-00	7018	Flare Nut, 3/8" x 3/8" ID barbed hose elbow	
			77-0401-00 7073 77-0409-00
<b>SPLICERS, STRAIGHT</b>			
77-0424-00	3130	Hose splicer, 1/2" x 1/2" ID barbed hose	
77-0402-00	9001	Hose splicer, 1/4" x 1/4" ID barbed hose	
77-0403-00	9013	Hose splicer, 3/8" x 3/8" ID barbed hose	
			77-0424-00 77-0402-00 77-0403-00
<b>SPLICER, REDUCING, STRAIGHT, HOSE</b>			
77-0407-00	9012	1/4" x 3/8" ID barbed hose, straight	
			77-0407-00
<b>SPLICER, REDUCING, TEE, HOSE</b>			
77-0607-00	9008	3/8" (2) x 1/4" (1) ID barbed hose tee	
			77-0607-00
<b>SPLICERS, TEE</b>			
77-0601-00	9006	Hose splicer, 1/4" (3) ID barbed hose, tee	
77-0609-00	9007	Hose splicer, 3/8" (3) ID barbed hose, tee	
			77-0601-00 77-0609-00
<b>SPLICERS, 90 DEGREE, HOSE</b>			
77-0404-00	9002	1/4" x 1/4" ID barbed hose, 90 degree	
77-0408-00	9005	3/8" x 3/8" ID barbed hose, 90 degree	
			77-0404-00 77-0408-00
<b>SPLICERS, U-BEND</b>			
77-9005-00	9051	Hose splicer, 1/4" (3) ID barbed hose, U-bend	
77-9002-02	9095	Hose splicer, 3/8" (3) ID barbed hose, U-bend	
			77-9005-00 77-9002-02
<b>SPLICER, CROSS</b>			
77-0602-00	9010	Hose splicer, 1/4" (4) ID barbed hose, cross	
			77-0602-00

Beverage Fittings

GIS Item #	Vendor #	Description
------------	----------	-------------

**PLUG, BARBED**

77-0107-00	9027	Plug, 1/4" ID barbed hose
77-0307-00	9028	Plug, 3/8" ID barbed hose



77-0107-00 77-0307-00

**MALE FLARE TO BARB ADAPTER**

77-0801-01	3015	1/4" MFL x 1/4" ID barbed hose
77-0804-02	3080	3/8" MFL x 1/4" ID barbed hose



77-0801-01 77-0804-02

**FLOJET PUMP FITTINGS, STRAIGHT INLET**

19-0443	3144	1/4" ID barbed hose
19-0434	3143	3/8" ID barbed hose



19-0443 19-0434

**COMPRESSION TO BARB**

S40-4-250	7263	1/4" female compression x 1/4" ID barbed hose
S40-4-370	7280	3/8" female compression x 1/4" ID barbed hose
S40-6-375	7264	3/8" female compression x 3/8" ID barbed hose



S40-4-250 S40-4-370 S40-6-375

<b><u>Stepless Ear Clamps (Oetiker)</u></b>			
16700003	8.7-505R Stepless Oetiker Ear Clamp		
16700006	10.5-505R Stepless Oetiker Ear Clamp		
16700007	11.3-505R Stepless Oetiker Ear Clamp		
16700009	12.3-706R Stepless Oetiker Ear Clamp		
16700010	13.3-706R Stepless Oetiker Ear Clamp		
16700012	14.0-706R Stepless Oetiker Ear Clamp		
16700013	14.5-706R Stepless Oetiker Ear Clamp		
16700016	15.7-706R Stepless Oetiker Ear Clamp		
16700017	17.0-706R Stepless Oetiker Ear Clamp		
16700022	19.8-706R Stepless Oetiker Ear Clamp		
16700024	21.0-706R Stepless Oetiker Ear Clamp		

**Oetiker Clamp Pincer, Pliers**

GIS Item # 31-1938-000  
Vendor Item # 14100083

*Clamp Pincer, Sidejaw 1099*



31-1938-000

 **Fittings, Inc.** 



**Beverage Fittings**

GIS Item #	Vendor #	Description
------------	----------	-------------

**MALE CONNECTOR**

PI-010822-S	PI010822S	1/4" tube OD x 1/4" thread (PI010822S)
PI-011222-S	PI011222S	3/8" tube OD x 1/4" thread (PI011222S)
PI-011223-S	PI011223S	3/8" tube OD x 3/8" thread (PI011223S)



PI-010822-S PI-011222-S PI-011223-S

**UNION ELBOW**

PI-031200-S	PI0312S	3/8" tube OD (PI0312S)
-------------	---------	------------------------



PI031200-S

**UNION CONNECTOR**

PI-040800-S	PI0408S	1/4" tube OD (PI0408S)
PI-041200-S	PI0412S	3/8" tube OD (PI0412S)



PI-040800-S PI-041200-S

**UNION TEE**

PI-020800-S	PI0208S	1/4" tube OD (PI0208S)
PI-021200-S	PI0212S	3/8" tube OD (PI0212S)



PI-020800-S PI-021200-S

**PLUG**

PI-081200-S	PI0812S	3/8" stem OD (PI0812S)
-------------	---------	------------------------



PI-081200-S

**SWIVEL BRANCH TEE**

PI101233-S	PI101233S	3/8" tube OD (2) x 3/8" thread (PI101233S)
------------	-----------	--



PI101233-S

**REDUCING ELBOW**

CRE-5-4	PI211008S	5/16" tube OD x 1/4" tube OD (PI211008S)
CRE-6-5	PI211210S	3/8" tube OD x 5/16" tube OD (PI211210S)



CRE-5-4 CRE-6-5

**TUBE to HOSE STEM**

PI-251208-S	PI251208S	3/8" stem OD x 1/4" hose ID (PI251208S)
PI-251212-S	PI251212S	3/8" stem OD x 3/8" hose ID (PI251212S)



PI-251208-S PI-251212-S

**TWO-WAY DIVIDER**

PI-231200-S	PI2312S	3/8" tube OD (PI2312S)
-------------	---------	------------------------



PI-231200-S

**REDUCING UNION CONNECTOR**

PI-201208-S	PI201208S	3/8" tube OD x 1/4" tube OD (PI201208S)
-------------	-----------	---



PI-201208-S

Many of the part numbers on this page have recently been changed by the manufacturer; however, the product information remains valid and will be cross-referenced at time of order.



Beverage Fittings

GIS Item #	Vendor #	Description
------------	----------	-------------

**END STOP (CAP)**

CES-4	PI4608S	1/4" tube OD (PI4608S)
CES-6	PI4612S	3/8" tube OD (PI4612S)



CES-4 CES-6

**CROSS**

PI-471200-S	PI4712S	3/8" tube OD (PI4712S)
-------------	---------	------------------------



PI-471200-S

**FEMALE FLARE CONNECTOR**

PI-4512F4-S	PI4512F4S	3/8" tube OD x 1/4" thread FFL (PI4512F4S)
PI-4512F6-S	PI4512F6S	3/8" tube OD x 3/8" thread FFL (PI4512F6S)



PI-4512F4-S PI-4512F6-S

**CHECK VALVE**

CFI3816S-VAL	3/8SCV	3/8" tube OD (3/8SCV)
--------------	--------	-----------------------



CFI3816S-VAL

**MALE FLARE CONNECTOR**

SM0108F4S	SM0108F4S	5/16" superseal OD x 1/4" thread MFL
-----------	-----------	--------------------------------------



SM0108F4S

**SPEEDFIT to SPEEDFIT SHUTOFF VALVE**

PPSV040808W	PPSV040808W	1/4" tube OD
CPPSV-6-6	PPSV041212W	3/8" tube OD (PPSV041212W)



PPSV040808W CPPSV-6-6

GIS Item #	Vendor #	Description
------------	----------	-------------

**Changeover Valve**

1421		Changeover Valve (Chudnow)
------	--	----------------------------



1421

**Backflow Preventer**

S470DVVP66X		ASSE 1032 Backflow Preventer (Chudnow)
-------------	--	--



S470DVVP66X

Primary CO2 Regulators for Soda Systems

3000 Series Primary Regulators



3741



SODA



Vendor #	Description	Pressure	Product	Working PSI Range	Gauge 1	Gauge 2	Outlet w/ Check	
3741	w/ side gauge HP	1	1	0-120 psi	160 lb	2000 lb	1/4" Flare	Stocked

5000 Series Primary Regulators



SODA



T5741PMHP  
(GIS # 5741-PMHP)



T5741PMHPB  
(GIS # 5741-PMHP-B)



Wall Mount

T5741WMHP-6  
(GIS # 5741WMHP-6)

Vendor #	Description	Pressure	Product	Working PSI Range	Gauge 1	Gauge 2	Outlet w/ Check	
T5741PMHP	w/ CGA320 Inlet, Red	1	1	0-120 psi	160 lb	2000 lb	1/4" Flare	N/S
T5741PMHPB	w/ CGA320 Inlet, Blue	1	1	0-120 psi	160 lb	2000 lb	1/4" Flare	Stocked
T5741WMHP-6	6' HP Hose w/ CGA320	1	1	0-120 psi	160 lb	2000 lb	1/4" Flare	N/S

N/S = Non-Stocked Item, requires special order and lead time.

Primary CO2 Regulators for Soda Systems

Primary CO2 Regulators w/ CGA320 Inlet



SODA



T8861-6  
(GIS # 8861-6)  
N/S

Vendor #	Description	Pressure	Product	Working PSI Range	Guage 1	Guage 2	Guage 3	Outlet w/ Check
T8861-6	1/4" Flare Inlet, 6' HP Hose	2	2	0-120 psi	100 lb	160 lb	2000 lb	1/4" Flare

N/S = Non-Stocked Item, requires special order and lead time.

CO2 Management Systems

Item #	Description	
C77002	Dual Stage Regulator - CO2 Management System	Stocked
C77004	CO2 Management System (Preset)	Stocked



Regulator Accessory

For use with Taprite regulators only

**Metal Gauge Guard for 2**

Part # **744GP**

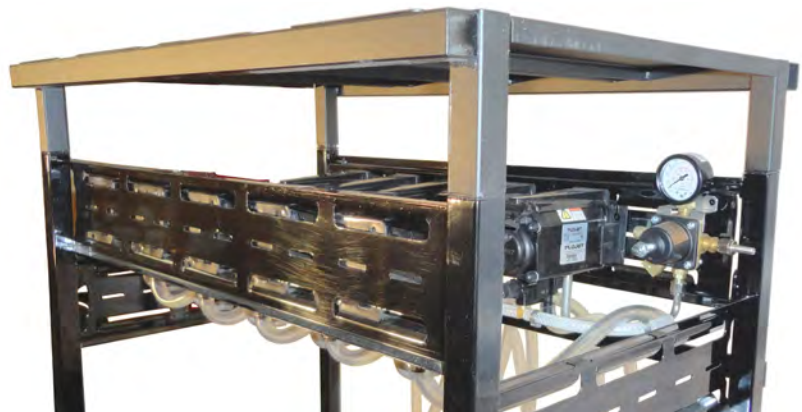

Primary CO2 Regulators for Soda Systems

Primary CO2 Regulators



283125111



283125115



283125126



283133111



283186111



283186115



283186122



283186126



770000280

Vendor #	Description	Pressure	Product	PSI	Outlet w/ Check	GIS Item #	
283125111		1	1	100 psi	1/4" Flare	28-3125-111	N/S
283125115		1	5	100 psi	1/4" Flare	28-3125-115	N/S
283125126		2	6	100 psi	1/4" Flare	28-3125-126	N/S
283133111		1	1	130 psi	1/4" Flare	28-3133-111	N/S
283186111	No Guard	1	1	30 psi	1/4" Flare	28-3186-111	Stocked
283186115		1	5	160 psi	1/4" Flare	28-3186-115	N/S
283186122		2	2	160 psi	1/4" Flare	28-3186-122	N/S
283186126		2	6	160 psi	1/4" Flare	28-3186-126	N/S
770000280		2	2	100/16 psi	1/4" Flare	77-0000-280	N/S

N/S = Non-Stocked Item, requires special order and lead time.

Item #	Description	GIS #	
183065000	Primary Regulator Repair Kit	18-3065-000	N/S

For use with Cornelius regulators only

N/S = Non-Stocked Item, requires special order and lead time.



183065000

Secondary CO2 Regulators for Soda Systems

5000 Series Secondary CO2 Regulators



T5272SNG

BIB Rack Mount



SODA



Vendor #	Description	Pressure	Product	Working PSI Range	Gauge 1	Gauge 2	Outlet w/ Check	
T5272SNG	1/4" Flare Inlet	2	2	0-120 psi	100 lb	100 lb	1/4" Flare	N/S

N/S = Non-Stocked Item, requires special order and lead time.

Secondary CO2 Regulators



283012111



283012122



283013126



SODA

Vendor #	Pressure	Product	PSI	Outlet w/ Check	GIS Item #	
283012111	1	1	100 psi	1/4" Flare	28-3012-111	Stocked
283012122	2	2	100 psi	1/4" Flare	28-3012-122	N/S
283013126	2	6	30/100 psi	1/4" Flare	28-3013-126	N/S

Item #	Description	GIS Item #	
183099000	Secondary Regulator Repair Kit	18-3099-000	Stocked

For use with Cornelius regulators only



183099000

N/S = Non-Stocked Item, requires special order and lead time.





Regulator Parts and Accessories



Regulator Parts and Accessories

<b>Pressure Gauge</b>
<b>Part # 39-0060-00</b>
<b>0-60 PSI</b>
<b>1/4" NPT Bottom Inlet</b>

<b>Pressure Gauge</b>
<b>Part # 39-0100-00</b>
<b>0-100 PSI</b>
<b>1/4" NPT Bottom Inlet</b>

<b>Pressure Gauge</b>
<b>Part # 39-0160-00</b>
<b>0-160 PSI</b>
<b>1/4" NPT Bottom Inlet</b>



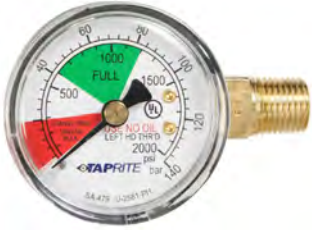

<b>Pressure Gauge</b>
<b>Part # 39-2000-10</b>
<b>0-2000 PSI</b>
<b>1/4" NPT Right Inlet</b>

<b>Pressure Gauge</b>
<b>Part # 39-3000-10</b>
<b>0-3000 PSI</b>
<b>1/4" NPT Right Inlet</b>



<b>Gold, Replacement Cap</b>
<b>Part # 740-501</b>
<b>For Series 1660, 5260</b>

<b>Silver, Replacement Cap</b>
<b>Part # 740-502</b>
<b>For Series 740</b>

<b>Black, Replacement Cap</b>
<b>Part # 740-503</b>
<b>For Series 5260, 5740</b>

<b>Red, Replacement Cap</b>
<b>Part # 740-504</b>
<b>For Series 740, 5740</b>

<b>Blue, Replacement Cap</b>
<b>Part # 740-505</b>
<b>For Series 5260, 5740</b>











<b>Silver, Rep. Bonnet Cap</b>
<b>Part # 740-552</b>
<b>For Series 740, 1660, 5260, 5740</b>

<b>Red, Rep. Bonnet Cap</b>
<b>Part # 740-554</b>
<b>For Series 740, 1660, 5260, 5740</b>

Note: All products listed above are non-stocked

Regulator Parts and Accessories

Regulator Parts and Accessories

<p><b>Bonnet Assembly</b></p> <p><b>Part # 3740-2PA</b></p> <p>For Series 3740</p>  <p>Black Zinc</p>	<p><b>Gold Cap, Bonnet Assy.</b></p> <p><b>Part # 740-601</b></p> <p>For Series 1660, 5260</p> 	<p><b>Silver Cap, Bonnet Assy.</b></p> <p><b>Part # 740-602</b></p> <p>For Series 740</p> 	<p><b>Black Cap, Bonnet Assy.</b></p> <p><b>Part # 740-603</b></p> <p>For Series 5200, 5700</p> 
<p><b>Red Cap, Bonnet Assy.</b></p> <p><b>Part # 740-604</b></p> <p>For Series 740HP, 5700HP</p> 	<p><b>Blue Cap, Bonnet Assy.</b></p> <p><b>Part # 740-605</b></p> <p>For Series 5260, 5740</p> 	 <p>440-17R</p>  <p>763</p>  <p>763D</p>  <p>2406-11</p>	

Item #	Description
440-17R	O-Ring for CO2 inlet fitting
763	Fiber Washer for CO2 tank con.
763D	CO2 Washer, Red Delrin
2406-11	O-Ring for Inlet Fitting

Item	Description
1600A	Outlet Fitting, Shutoff, 1/4" NPT x 5/16" Hose Barb
1600C-250	Outlet Fitting, Shutoff, 1/4" NPT x 1/4" Hose Barb, w/ Ball Chk Val
1600CA	Outlet Fitting, Shutoff, 1/4" NPT x 5/16" Hose Barb, w/ Ball Chk Val
440-12	Inlet Fitting, Nipple, 1/4" NPT, Right Hand
40-13UD	Inlet Fitting, Nut, for CO2 Tank Connection, CGA320
5153B	Inlet Fitting, Flare, 1/4" NPT x 1/4" Flare, for Sec. Reg, No Check Val
5375-25	Nipple, Connector, 1/4" NPT, 9/16" Hex, for Sec. Reg.
5436	Outlet Fitting, Flare, 1/4" Flare x 1/4" NPT w/ Chk, for Sec. Reg.
5436A	Outlet Fitting, Flare, 1/4" Flare x 1/4" NPT w/ Chk, for Prim. Reg.
5436H	Outlet Fitting, Barb, 1/4" Barb x 1/4" NPT w/ Chk, for Sec. Reg.
5436HA	Outlet Fitting, Barb, 1/4" Barb x 1/4" NPT w/ Chk, for Prim. Reg.
5460	Outlet Fitting, "Y" 1/4" NPT (male) x (2) 1/4" NPT (female)
6153B	Inlet Fitting, Flare, 1/4" NPT (left hand) x 1/4" Flare, for Prim. Reg.
6600A	Outlet Fitting, Shutoff, 1/4" NPT x 1/4" Flare, No Chk Val
6600CA	Outlet Fitting, Shutoff, 1/4" NPT x 1/4" Flare, w/ Chk Val
6618BL-2	Nipple, Connector, 1/4" NPT, 9/16" Hex, for Prim. Reg.
665U	Plug, 1/4" NPT, 9/16" Hex, Right Hand Threads, for Sec. Reg.
70030L-DB312	Shutoff Valve, 1/4" NPT x 5/16" Hose Barb, w/ Duckbill Chk Val
740-12	Inlet Fitting, Nipple w/ O-Ring Tank Seal, Left Hand Threads
740-12N	N2 Inlet Fitting, Nipple w/ O-Ring Tank Seal, Left Hand Threads
740-13N	Inlet Fitting, Nut, Male Threads, CGA580
740-16	Plug, Left Hand Threads, Allen Socket Head for Prim. Reg.
740-19	Inlet Fitting, Nipple Assembly w/ Flat Ring Tank Seal, CGA320



Note: A few of the products listed are non-stocked

## Beverage Tubing and Hoses



Item #	Description	UOM
<b>Bev-Seal Ultra 974 Cabled Barrier Bundle Tubes</b>		
974-08020-01	8-1/4" & 2-3/8" Tubes	100ft Wrapped Coil
974-08020-02	8-1/4" & 2-3/8" Tubes	200ft Reel
974-08020-05	8-1/4" & 2-3/8" Tubes	500ft Reel
974-08040-01	8-1/4" & 4-3/8" Tubes	100ft Wrapped Coil
974-08040-02	8-1/4" & 4-3/8" Tubes	200ft Reel
974-08040-05	8-1/4" & 4-3/8" Tubes	500ft Reel
974-10020-01	10-1/4" & 2-3/8" Tubes	100ft Wrapped Coil
974-10020-02	10-1/4" & 2-3/8" Tubes	200ft Reel
974-10020-05	10-1/4" & 2-3/8" Tubes	500ft Reel
974-10040-01	10-1/4" & 4-3/8" Tubes	100ft Wrapped Coil
974-10040-02	10-1/4" & 4-3/8" Tubes	200ft Reel
974-10040-05	10-1/4" & 4-3/8" Tubes	500ft Reel
974-00100-01	10-3/8" Tubes	100ft Wrapped Coil
974-00100-02	10-3/8" Tubes	200ft Reel
974-00100-04	10-3/8" Tubes	400ft Reel
974-00100-05	10-3/8" Tubes	500ft Reel
974-00120-01	12-3/8" Tubes	100ft Wrapped Coil
974-00120-02	12-3/8" Tubes	200ft Reel
974-00120-05	12-3/8" Tubes	500ft Reel
974-00140-01	14-3/8" Tubes	100ft Wrapped Coil
974-00140-02	14-3/8" Tubes	200ft Reel
974-00140-05	14-3/8" Tubes	500ft Reel

<b>Bevlex Series 200 Clear PVC Tubing (for BIB)</b>		
200-0307	3/16"ID X 7/16"OD	100ft Coil, Boxed
200-0408	1/4"ID X 1/2"OD	100ft Coil, Boxed
200-0509X100	5/16"ID X 9/16"OD	100ft Payout Carton
200-0609	3/8"ID X 9/16"OD	100ft Coil, Boxed
200-0610X100	3/8"ID X 5/8"OD	100ft Payout Carton

<b>Series 213 Black PVC Drain Tubing</b>		
213-0812	1/2"ID X 3/4" OD	100ft Coil, Boxed
213-1014	5/8"ID X 7/8"OD	100ft Coil, Boxed
213-1216	3/4"ID X 1"OD	100ft Coil, Boxed
213-1620	1"ID X 1-1/4"OD	100ft Wrapped Coil

<b>Series 215 PVC Drain Tubing</b>		
215-06100-00	Gray 3/8"ID X 5/8"OD	100ft Payout Carton
215-08120-00	Gray 1/2"ID X 3/4"OD	100ft Payout Carton
215-10140-00	Gray 5/8"ID X 7/8"OD	100ft Coil, Boxed
215-12160-00	Gray 3/4"ID X 1"OD	100ft Coil, Boxed
213-16200-00	Black 1"ID X 1-1/4"OD	100ft Wrapped Coil

**Bev-Seal Ultra 974 Bundled Tubing:** Flushable Bev-Seal Ultra® Series 235 tubes, each color coded, individually numbered and branded with NSF-51 and NSF-61 listings and date codes for traceability. Special film wrap over cabled tubes offers excellent flexibility and tight bend capabilities. Silver-gray extruded jacket, with slip agent to minimize friction, is branded with product identification, NSF listing marks, and sequential footage markings for ease of measurement.



**Series 200 Clear PVC Tubing:** Dual durometer construction combines a low extraction inner contact surface with a flexible outer layer for excellent kink resistance and taste protection properties. Clear Food Grade liner materials free from colorants.



**Series 213 and 215 PVC Drain Tubing:** Industrial grade PVC tube construction providing lightweight flexibility, kink-resistance and economy.

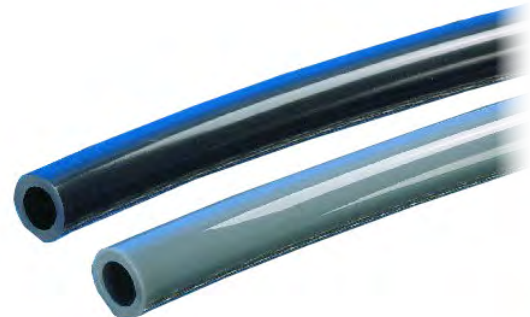



## Beverage Tubing and Hoses

Bevlex® Series 170 Polyester-Reinforced Polyethylene Beverage Hose:



Item #	Description	UOM
<b>Bevlex Series 170 Poly-Reinforced Hose</b>		
170-04102-77	.265"ID X .457" OD	100ft Coil, Boxed
170-04504-00	.265"ID X .457" OD	500ft Spool, Boxed
170-06300-00	.380"ID X .593" OD	300ft Spool, Boxed
170-06100-77	.380"ID X .593" OD	100ft Coil, Boxed
170-06301-00	.380"ID X .635" OD	300ft Spool, Boxed

### Bev-Flex Series 172 Poly-Reinforced Hose

172-04102-77	.265"ID X .457" OD	100ft Coil, Boxed
172-04502-00	.265"ID X .457" OD	500ft Spool, Boxed
172-06100-77	.380"ID X .593" OD	100ft Coil, Boxed
172-06300-00	.380"ID X .593" OD	300ft Spool, Boxed

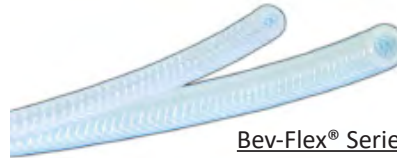

Bev-Flex® Series 172 Polyester-Reinforced Polyethylene Beverage Hose:

Bev-Seal Ultra® Series 175 Barrier Hose: Oxygen and Flavor barrier properties combined with flushability in a yarn-reinforced hose.

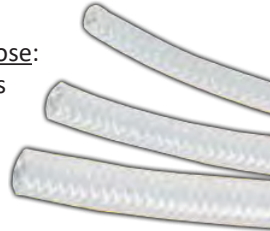

### Bev-Seal Ultra Series 175 Barrier Hose

175-04500-XX	.265"ID X .420"OD	500ft Spool, Boxed
175-06300-XX	.375"ID X .535"OD	300ft Spool, Boxed
175-08300-XX	.510"ID X .675"OD	300ft Spool, Boxed

### CLEARBRAID Series K3150 Reinforced Hose

K3150-03X300	3/16" ID X 3/8" OD	300 ft Coil
K3150-04X300	1/4" ID x .438" OD	300 ft Coil
K3150-06X300	3/8" ID x .594" OD	300 ft Coil
K3150-08X300	1/2" ID x 3/4" OD	300 ft Coil

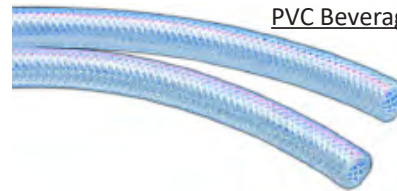

CLEARBRAID® K3150 Series Reinforced PVC Beverage Hose:

Sani-Clean AM™ Series 218 Drain Tubing: Anti-microbial for bacteria, fungi, mold, and yeast.



### Drain Tubing - Sani-Clean Anti-Microbial 218

218-0610X100	3/8"ID X 5/8"OD	100ft Payout Carton
218-0812X100	1/2"ID X 3/4"OD	100ft Payout Carton
218-1014X100	5/8"ID X 7/8"OD	100ft Coil, Boxed
218-1216X100	3/4"ID X 1"OD	100ft Coil, Boxed

### Bev-Seal Ultra Dual Barrier Series 235 Tubing

235-0562X1K	.190"ID X .313"OD	1,000ft Spool,Boxed
235-06620-XX	.265"ID X .375"OD	500ft Spool, Boxed
235-08620-XX	.380"ID X .500"OD	500ft Spool, Boxed
235-10620-XX	.510"ID X .625"OD	500ft Wrapped Coil

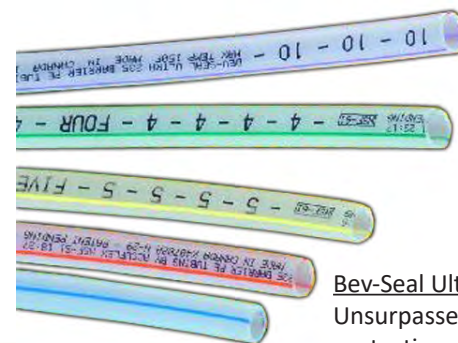

Bev-Seal Ultra® Series 235 Tubing: Unsurpassed oxygen and flavor protection combined with flushability in a coextruded tube.



Payout Carton



Wrapped Coil



Spool or Reel



### Tools and Accessories

**Part # 31-1938-000**

Clamp pincer, pliers  
Sidejaw 1099

Use w/ Oetiker stepless clamps



Stocked

**Part # 959-01**

Kuri Snip Cutter - cuts up to  
1/2" OD hose and tubing

Used to clean & square up ends



Stocked

**Part # 959-03**

Replacement blade  
for the Kuri Snip Cutter

for Accuflex part # 959-01



Stocked

**Part # 954-01**

Large Cutter - cuts up to  
1 7/8" OD hose and tubing

for Accuflex hose & tubing



Stocked

**Part # 954-03**

Replacement blade  
for Large Cutter

for Accuflex part # 954-01



Stocked

**Part # 119084**

Jumbo Cutter - cuts up to  
2 1/2" OD hose and tubing

for Accuflex hose & tubing



Stocked



STL Series - Cup and Lid Dispensers

STL Series Adjustable Cup Dispensers (ABS Plastic)

In-Counter One-Size-Fits-All Adjustable Plastic Cup Dispensers

For use with 8 oz. to 44 oz. cups

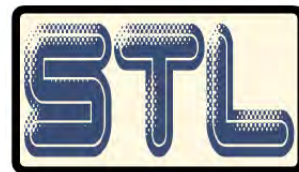

Vendor #	# of Springs	Type Spring	Length (Inches)	
STL-2	2	F and P	22"	
STL-2S	2	F and P	17"	N/S
STL-2L	2	F and P	28"	N/S
STL-2F	1	F	22"	
STL-2FS	1	F	17"	

N/S = Non-Stocked Item, requires special order and lead time.

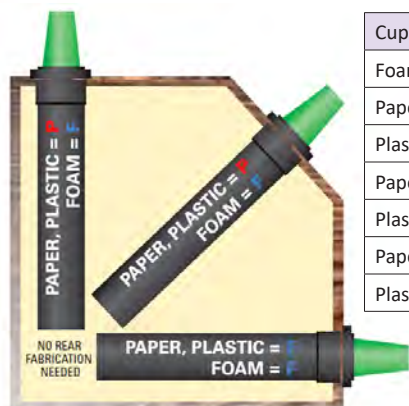

Cup Type	Position	Spring
Foam Cups	Any Position	F Spring
Paper Cups	Horizontal	F Spring
Plastic Cups	Horizontal	F Spring
Paper Cups	Angled	P Spring
Plastic Cups	Angled	P Spring
Paper Cups	Vertical	P Spring
Plastic Cups	Vertical	P Spring

Item #	Description
STL2R-SS	Silver Satin Color Bezel (Optional)
STL-2-SMB	Undercounter Mounting Bracket



STL2R-SS



STL-2-SMB  
For STL and SLR



Example

Vendor #	# of STL Dispensers	
STL-S-2BT	2	
STL-S-3BT	3	
STL-S-4BT	4	

STL-SL-2BT	2	
STL-SL-3BT	3	
STL-SL-2X2BT	4	

STL-C-3RBT	3	N/S
STL-C-3LBT	3	N/S
STL-C-4RBT	4	
STL-C-4LBT	4	

STL Cup Dispensing Cabinets



STL-S-2BT

STL-S-3BT

STL-S-4BT

STL-SL-2BT

STL-SL-3BT

STL-SL-2X2BT



STL-C-3RBT



STL-C-3LBT



STL-C-4RBT



STL-C-4LBT

Adjustable Spring Clips on all STL models



SLR Series - Cup and Lid Dispensers

SLR Series Interchangeable Baffle Cup Dispensers

In-Counter One-Size-Fits-All Interchangeable Baffle Cup Dispensers  
For use with 8 oz. to 44 oz. cups



(ABS Plastic)

Vendor #	# of Springs	Type Spring	Length (Inches)	
SLR-2	2	F and P	22"	
SLR-2S	2	F and P	17"	N/S
SLR-2L	2	F and P	28"	N/S
SLR-2F	1	F	22"	



For use with 4 oz. to 24 oz. cups

Vendor #	# of Springs	Type Spring	Length (Inches)	
SLR-1	2	F and P	22"	N/S
SLR-1S	2	F and P	17"	N/S
SLR-1F	1	F	22"	N/S

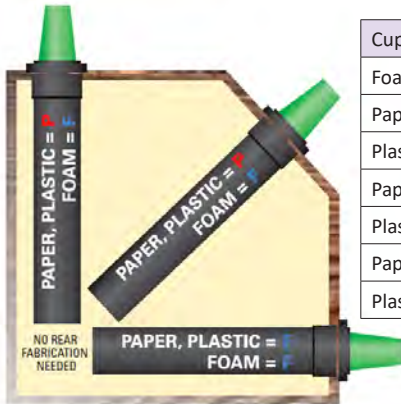

Cup Type	Position	Spring
Foam Cups	Any Position	F Spring
Paper Cups	Horizontal	F Spring
Plastic Cups	Horizontal	F Spring
Paper Cups	Angled	P Spring
Plastic Cups	Angled	P Spring
Paper Cups	Vertical	P Spring
Plastic Cups	Vertical	P Spring

Item #	Description
SLR2R-SS	Silver Satin Color Bezel (Optional)

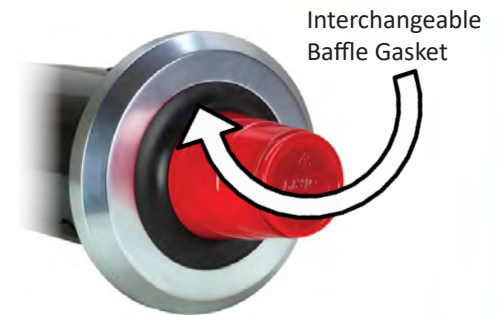

SLR-1 Slim-Line model for 4 oz. to 24 oz. cups is available (not shown)

SLR Cup Dispensing Cabinets

Vendor #	# of SLR Dispensers	
SLR-S-2BT	2	
SLR-S-3BT	3	N/S
SLR-S-4BT	4	

SLR-SL-2BT	2	
SLR-SL-3BT	3	N/S
SLR-SL-2X2BT	4	N/S

SLR-C-3RBT	3	N/S
SLR-C-3LBT	3	N/S
SLR-C-4RBT	4	N/S
SLR-C-4LBT	4	N/S



Stainless Steel Models Available for SLR Cabinets (not shown)

ADJ Series - Cup Dispensers

ADJ Series Adjustable Cup Dispensers (Stainless Steel)



ADJ-1 or ADJ-1.5



Adjustable Spring Clips on all ADJ models

**In-Counter Slim-Line Adjustable Cup Dispensers**

For small cup sizes and tight spaces.

Vendor #	# of Springs	Type Spring	Length (Inches)	Cup Rim Diameter	Cup Sizes	
ADJ-1	2	F and P	22"	2 1/2" - 3 1/2"	4 oz. to 12 oz.	N/S
ADJ-1.5	2	F and P	22"	3" - 3 7/8"	8 oz to 24 oz.	N/S

**In-Counter One-Size-Fits-All Adjustable Cup Dispensers**  
For use with 8 oz. to 44 oz. cups

Vendor #	# of Springs	Type Spring	Length (Inches)	
ADJ-2	2	F and P	22"	
ADJ-2S	2	F and P	19"	N/S
ADJ-2F	1	F	22"	



ADJ-2



ADJ-2S

Item #	Description	
ADJ2RA-BLK1	Bumper Black Color Bezel (High Gloss) (Optional)	
UCMB-2	Stainless Steel Undercounter Mounting Bracket	



ADJ2RA-BLK1  
For ADJ-2 and ADJ-2S



UCMB-2  
For ADJ-2 Series



ADJ-3

**In-Counter JUMBO-Size Adjustable Cup Dispenser**

For large cup sizes 44 oz. to 64 oz.

Vendor #	# of Springs	Type Spring	Length (Inches)	Cup Rim Diameter	Cup Sizes	
ADJ-3	2	F and P	22"	4 1/2" - 5 1/4"	44 oz. to 64 oz.	N/S

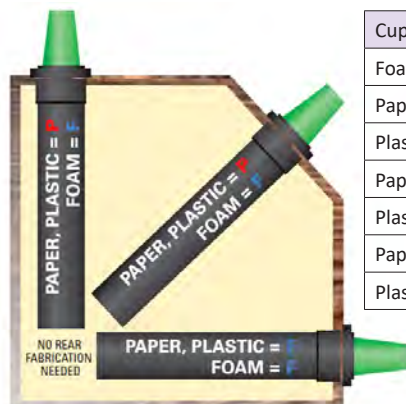

Cup Type	Position	Spring
Foam Cups	Any Position	F Spring
Paper Cups	Horizontal	F Spring
Plastic Cups	Horizontal	F Spring
Paper Cups	Angled	P Spring
Plastic Cups	Angled	P Spring
Paper Cups	Vertical	P Spring
Plastic Cups	Vertical	P Spring

**ADJ Series In-Counter Adjustable Cup Dispensers:** Quality stainless steel construction with a quick release mounting collar. These dispensers utilize an exclusive spring-clip precision adjustment mechanism to accommodate a full range of cup sizes from 4 oz. to 64 oz. All models are NSF listed.

N/S = Non-Stocked Item, requires special order and lead time.

CTC Series - Cup Dispensing Cabinets

CTC One-Size-Fits-All Cup Dispensing Cabinets

Uses the ADJ-2 Series Cup Dispenser (Included)

For 8 oz. to 44 oz. cups



Vendor #	# of ADJ Dispensers	Measurements (W x D x H)	
CTC-R-2SS	2	8 1/8" x 23" x 16 1/2"	N/S
CTC-R-3SS	3	8 1/8" x 23" x 24 1/2"	N/S
CTC-R-4SS	4	8 1/8" x 23" x 32 1/2"	N/S

CTC-L-2SS	2	8 3/8" x 23 1/2" x 22 3/4"	N/S
CTC-L-3SS	3	8 3/8" x 23 1/2" x 29 3/8"	N/S
CTC-L-2X2SS	4	16 1/2" x 22 3/4" x 22 3/4"	N/S

CTC-S-2BT	2	8" x 23" x 16 1/4"	N/S
CTC-S-3BT	3	8" x 23" x 24 1/4"	N/S
CTC-S-4BT	4	8" x 23" x 32 1/4"	N/S

CTC-C-2BT	2	13" x 23" x 16 1/4"	
CTC-C-3BT	3	13" x 23" x 24 1/4"	
CTC-C-4BT	4	13" x 23" x 32 1/4"	N/S

CTC-M-3BT	3	11" x 23" x 32 1/4"	
-----------	---	---------------------	--

CTC-C-3RSS	3	13" x 23" x 25 3/8"	N/S
CTC-C-3LSS	3	13" x 23" x 25 3/8"	N/S
CTC-C-4RSS	4	13" x 23" x 32 1/2"	
CTC-C-4LSS	4	13" x 23" x 32 1/2"	



CTC-R-2SS    CTC-R-3SS    CTC-R-4SS



CTC-L-2SS    CTC-L-3SS    CTC-L-2X2SS



CTC-S-2BT    CTC-S-3BT    CTC-S-4BT

CTC Series Cup Dispensing Cabinets:

All CTC series cabinets have ADJ-2 cup dispensers included. The SS designated cabinets are of quality stainless steel construction. The BT designated cabinets are made of durable and stylish polystyrene construction.



CTC-C-2BT    CTC-C-3BT    CTC-C-4BT    CTC-M-3BT    CTC-C-3RSS    CTC-C-3LSS    CTC-C-4RSS    CTC-C-4LSS

BFL Series - Cup and Lid Dispensers

BFL Series In-Counter Interchangeable Baffle Cup Dispensers

BFL Series In-Counter Interchangeable Baffle Cup Dispensers:

Quality stainless steel construction. These dispensers utilize an interchangeable silicone baffle gasket system to accommodate a full range of cup sizes from 8 oz. to 64 oz. All models are NSF listed.

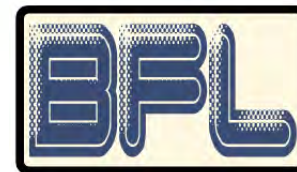

**In-Counter Interchangeable Baffle Cup Dispensers**  
For use with 8 oz. to 44 oz. cups

Vendor #	# of Springs	Type Spring	Length (Inches)	
BFL-2	2	F and P	22"	
BFL-2S	2	F and P	19"	N/S
BFL-2F	1	F	22"	N/S



BFL-2



BFL-2S

Item #	Description	
BFL2RA-BLK2	Black Ridge Color Bezel (Optional)	N/S
UCMB-2	Stainless Steel Undercounter Mounting Bracket	N/S



BFL2RA-BLK2  
For BFL-2 and BFL-2S



UCMB-2  
For BFL-2 Series



BFL-3

**In-Counter JUMBO-Size Adjustable Cup Dispenser**

For large cup sizes 44 oz. to 64 oz.

Vendor #	# of Springs	Type Spring	Length (Inches)	Cup Rim Diameter	Cup Sizes	
BFL-3	2	F and P	22"	4 1/2" - 5 1/4"	44 oz. to 64 oz.	N/S

N/S = Non-Stocked Item, requires special order and lead time.

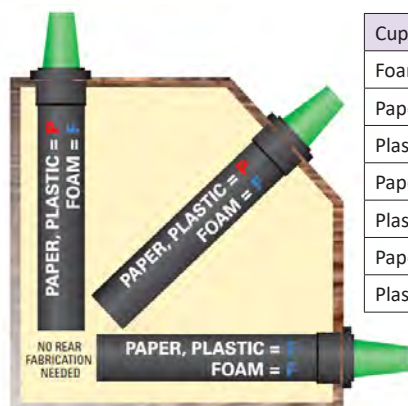

Cup Type	Position	Spring
Foam Cups	Any Position	F Spring
Paper Cups	Horizontal	F Spring
Plastic Cups	Horizontal	F Spring
Paper Cups	Angled	P Spring
Plastic Cups	Angled	P Spring
Paper Cups	Vertical	P Spring
Plastic Cups	Vertical	P Spring

Interchangeable silicone baffle gasket

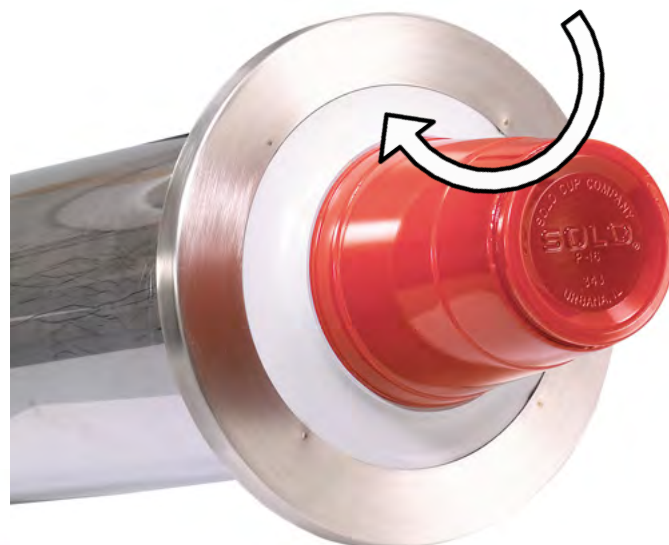

BFL Series - Cup Dispensing Cabinets

BFL Series Dispensing Cabinets

Uses the BFL-2 Series Cup Dispenser (Included)

For 8 oz. to 44 oz. cups



Vendor #	# of BFL Dispensers	Measurements (W x D x H)	
BFL-R-2SS	2	8 1/8" x 23" x 16 1/2"	N/S
BFL-R-3SS	3	8 1/8" x 23" x 24 1/2"	N/S
BFL-R-4SS	4	8 1/8" x 23" x 32 1/2"	N/S

BFL-L-2SS	2	8 3/8" x 23 1/2" x 22 3/4"	N/S
BFL-L-3SS	3	8 3/8" x 23 1/2" x 29 3/8"	N/S
BFL-L-2X2SS	4	16 1/2" x 22 3/4" x 22 1/2"	N/S

BFL-S-2BT	2	8" x 23" x 16 1/4"	N/S
BFL-S-3BT	3	8" x 23" x 24 1/4"	
BFL-S-4BT	4	8" x 23" x 32 1/4"	

BFL-C-2BT	2	13" x 23" x 16 1/4"	N/S
BFL-C-3BT	3	13" x 23" x 24 1/4"	
BFL-C-4BT	4	13" x 23" x 32 1/4"	

BFL-C-3RSS	3	13" x 23" x 25 3/8"	N/S
BFL-C-3LSS	3	13" x 23" x 25 3/8"	N/S
BFL-C-4RSS	4	13" x 23" x 32 1/2"	N/S
BFL-C-4LSS	4	13" x 23" x 32 1/2"	N/S



BFL-R-2SS BFL-R-3SS BFL-R-4SS



BFL-L-2SS BFL-L-3SS BFL-L-2X2SS



BFL-S-2BT BFL-S-3BT BFL-S-4BT



BFL-C-2BT BFL-C-3BT BFL-C-4BT BFL-C-3RSS BFL-C-3LSS BFL-C-4RSS BFL-C-4LSS

N/S = Non-Stocked Item, requires special order and lead time.

BFL Series Cup Dispensing Cabinets:

All BFL series cabinets have BFL-2 cup dispensers included. The SS designated cabinets are of quality stainless steel construction. The BT designated cabinets are made of durable and stylish polystyrene construction.



## ADJ Series - Cup Dispensers

ADJ-NW and ADJ-NS Series Adjustable Cup Dispensers:

Quality stainless steel construction. These dispensers provide simple and fast adjustment of five models in each category. Refer to sizing chart for proper sized cup dispenser.

All models are NSF listed.



### ADJ-NW Adjustable Cup Dispensers (Stainless Steel)

#### **Pull-Type (gravity feed) Surface or Stand Mounted Cup Dispensers**

**ADJ Series cup dispenser using a bracket for wall, surface, or stand mounting.**

*Includes two stainless steel mounting brackets.*

Top Loading

Vendor #	Length (Inches)	Tube Diameter	Paper/Plastic Cup Sizes	Foam Cup Sizes	
ADJ-NW-21	25 1/5"	3 5/16"	6 oz. to 12 oz.	6 oz. to 8 oz.	N/S
ADJ-NW-31	25 1/5"	3 11/16"	12 oz. to 22 oz.	8 oz. to 12 oz.	N/S
ADJ-NW-81	25 1/5"	4 1/8"	14 oz. to 24 oz.	12 oz. to 24 oz.	N/S
ADJ-NW-101	25 1/5"	4 5/8"	32 oz.	32 oz.	N/S
ADJ-NW-151	25 1/5"	4 7/8"	44 oz.	32 oz. to 44 oz.	N/S

### ADJ-NS Adjustable Cup Dispensers (Stainless Steel)

#### **Spring-Loaded for horizontal or vertical mounting positions only.**

*Includes two stainless steel mounting brackets.*

Vendor #	Length (Inches)	Tube Diameter	Paper/Plastic Cup Sizes	Foam Cup Sizes	
ADJ-NS-21	25 1/5"	3 5/16"	6 oz. to 12 oz.	6 oz. to 8 oz.	N/S
ADJ-NS-31	25 1/5"	3 11/16"	12 oz. to 22 oz.	8 oz. to 12 oz.	N/S
ADJ-NS-81	25 1/5"	4 1/8"	14 oz. to 24 oz.	12 oz. to 24 oz.	N/S
ADJ-NS-101	25 1/5"	4 5/8"	32 oz.	32 oz.	N/S
ADJ-NS-151	25 1/5"	4 7/8"	44 oz.	32 oz. to 44 oz.	N/S

N/S = Non-Stocked Item, requires special order and lead time.

Item #	Description	
<b>EZ-3EZ</b>	Countertop Stand for (3) ADJ-NW Series cup dispensers and/or TLD Series lid dispensers	N/S

*EZ-3EZ for use with ADJ-NW and TLD models only.*

*See page 9 for TLD Tubular Lid Dispensers*

EZ-3EZ



Example

N/S = Non-Stocked Item, requires special order and lead time.

## SFL Series - Cup and Lid Dispensers



SFL-ADJ and SFL-TLD Series Portion Cup and Lid Dispensers:

Quality stainless steel construction. The SFL-ADJ dispenser is top loading and self-adjusting. It's idea for use with portion cups for condiments and dressings. The SFL-TLD is a front-loading lid dispenser used as a complement to the SFL-ADJ. All models are NSF listed.

### SFL Series Surface or Stand Mount Portion Cup Dispenser

#### **Pull-Type (gravity feed) Surface or Stand Mounted Cup Dispenser**

**SFL Series portion cup dispenser uses a bracket for wall, surface, or stand mounting.**

*Includes one stainless steel mounting bracket.*

Top Loading

Vendor #	Length (Inches)	Tube Diameter	Paper/Plastic Cup Sizes	Foam Cup Sizes	
SFL-ADJ	12"	3 5/8"	2 oz. to 6 oz.	2 oz. to 6 oz.	N/S



SFL-ADJ

### SFL Series Surface or Stand Mount Lid Dispenser

#### **Front loading Surface or Stand Mounted Lid Dispenser**

**SFL Series lid dispenser uses a bracket for wall, surface, or stand mounting.**

*Includes one stainless steel mounting bracket.*

Front Loading

Vendor #	Length (Inches)	Tube Diameter	Paper/Plastic Cup Sizes	Foam Cup Sizes	
SFL-TLD	12"	3 1/8"	2 oz. to 6 oz.	2 oz. to 6 oz.	N/S



SFL-TLD

Item #	Description	
SFL-STAND-1	Countertop polystyrene stand used to mount (1) SFL-ADJ or (1) SFL-TLD dispenser.	N/S
SFL-STAND-2	Countertop polystyrene stand used to mount (2) SFL-ADJ or (2) SFL-TLD dispensers or (1) of each.	N/S

*SFL-STAND-1 and SFL-STAND-2 for use with SFL-ADJ and SFL-TLD only.*



SFL-STAND-1



SFL-STAND-2



Examples

## TLD Series - LID Dispensers

### TLD Series Tubular Lid Dispensers:

Quality stainless steel construction. These lid dispensers can be mounted to a wall, surface, or attached to the EZ-3EZ countertop stand.

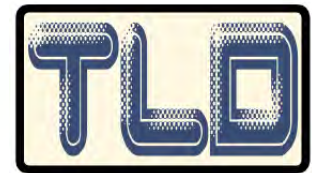

### TLD Tubular Lid Dispensers (Stainless Steel)

#### Front Loaded Surface or Stand Mounted Lid Dispensers

Includes two stainless steel mounting brackets.

Vendor #	Length (Inches)	Tube Diameter	Max Lid Size	
TLD-2-2	25 1/2"	4 1/4"	6 oz. to 24 oz.	N/S
TLD-3-3	25 1/2"	4 7/8"	12 oz. to 44 oz.	N/S



TLD-2-2



TLD-3-3

Item #	Description	
EZ-3EZ	Countertop Stand for (3) ADJ-NW Series cup dispensers and/or TLD Series lid dispensers	N/S

*EZ-3EZ for use with ADJ-NW and TLD models only.*

*See page 7 for product image*

## SLR Series - Lid and Straw Dispensers

### SLR-LID-2 Series In-Counter Spring-Loaded Lid Dispensers:

This lid dispenser requires no adjustment and is available for a variety of in-counter and countertop applications. **Important note on lid compatibility: The SLR-LID-2 Series lid dispensers are primarily for use with flat, cold beverage lids. Lids that are tightly nested or have deep extrusions may not be compatible.**



### SLR Series Lid Dispensers

Vendor #	Length (Inches)	Maximum Lid Diameter	Ring Bezel Diameter	
SLR-LID-2	22"	4 5/8"	7 1/8"	N/S
SLR-LID-2S	17"	4 5/8"	7 1/8"	N/S



SLD-LID-2 Series

### SLR Series Straw Dispenser

Vendor #	Length (Inches)	Ring Bezel Diameter	
SLR-STRAW-2	12"	7 1/8"	N/S



SLR-STRAW-2

Item #	Description	
UCMB-1BT	Surface bracket for mounting (1) dispenser	N/S
UCMB-2BT	Surface bracket for mounting (2) dispensers	N/S
UCMB-3BT	Surface bracket for mounting (3) dispensers	N/S



USMB-1BT

USMB-2BT

USMB-3BT

Brackets can also be used with STL-2, SLR-2, ADJ-2, or BFL-2 Series Cup Dispensers.

N/S = Non-Stocked Item, requires special order and lead time.

LID Series - Dispensing Cabinets

SLR-LID-2 Series Dispensing Cabinets

For 8 oz. to 44 oz. paper, plastic, or foam cups and/or lids with rim diameters ranging in size from 3" to 4 1/2" Note: Not all lids are compatible.



LID2-S1-2BT



LID2-S1-3BT



LID2-S2-2BT



LID2-S2-3BT

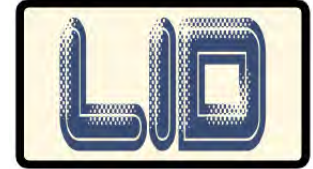

Vendor #	# of Dispensers	Measurements (W x D x H)	Type of Dispensers Included	
LID2-S1-2BT	2	8" x 23" x 16 1/4"	(2) SLR-LID-2	N/S
LID2-S1-3BT	3	8" x 23" x 24 1/4"	(3) SLR-LID-2	N/S
LID2-S2-2BT	2	8" x 23" x 16 1/4"	(1) SLR-2F and (1) SLR-LID-2	N/S
LID2-S2-3BT	3	8" x 23" x 24 1/4"	(1) SLR-2F, (1) SLR-LID-2, and SLR-STRAW-2	N/S





SLR-LID-2 Series Dispensing Cabinets:

These countertop dispensing cabinets combine lid, cup, and straw dispensers with a durable and stylish polystyrene housing.

## BUILD YOUR OWN COUNTERTOP STACKABLE CUP, LID, & STRAW SYSTEM

- Modular stackable cabinet design
- Variety of configurations
- Short cabinet depth for limited space
- Add a condiment organizer to complete the system



Condiment Organizer	SLR Cup Dispenser	Lid Dispenser	Straw Dispenser
Part # <b>NLO-STK-1BT</b>	Part # <b>SLR-STK-1BT</b>	Part # <b>LID-STK-1BT</b>	Part # <b>STR-STK-1BT</b>
			
N/S	N/S	N/S	N/S
8" W x 19 1/8" D x 7 1/8" H	8" W x 18 1/2" D x 8 1/4" H	8" W x 18 1/2" D x 8 1/4" H	8" W x 18 1/2" D x 8 1/4" H

Countertop Wire Cup, Lid & Straw Dispensing Racks

WR Series Dispensing Organizers

These are versatile wire racks which accommodates a variety of cup and lid sizes. They provide a maximum dispensing solution in a minimum amount of counter space.



WR-3



WR-4



WR-5



EXAMPLE

Vendor #	# of Sections	Measurements (W x D x H)	Description
WR-3	3	14 1/2" x 5" x 8 1/2"	3-Sections: (1) 3 1/2"; (1) 4 1/4"; (1) 4 3/4"
WR-4	4	18 1/2" x 5" x 8 1/2"	4-Sections: (4) 4 1/8"
WR-5	5	23" x 5" x 8 1/2"	5-Sections: (1) 3 1/2"; (2) 4 1/4"; (2) 4 3/4"

Item #	Description	
<b>WR-STAND</b>	Optional: Used to elevate the WR Series organisers for easier access to cups, lids, and straws	N/S
<b>WR-STRAW</b>	Optional: Accessory addition to add straw dispense	N/S

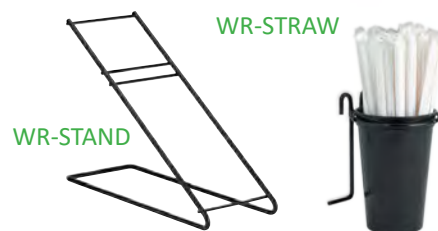

N/S = Non-Stocked Item, requires special order and lead time.

WR-CT Series Vertical Dispensing Organizers

Vendor #	# of Sections	Measurements (W x D x H)	
WR-CT-3	3	6 1/4" x 20" x 19 1/4"	
WR-CT-4	4	6 1/4" x 20" x 24 3/4"	
WR-CT-5	5	6 1/4" x 20" x 29 3/4"	N/S

Item #	Description
<b>WR-CT-LID</b>	Optional: Lid Dispenser Insert

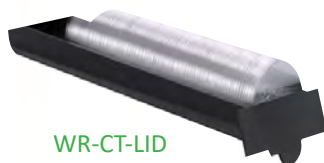

WR-CT-LID

The WR-CT-LID creates a storage area for lids up to 4 3/8" in diameter.



EXAMPLE



WR-CT-3

WR-CT-4

WR-CT-5

**WR-CT Series:**

These units dispense 6 oz to 44 oz paper, plastic or foam cups with rim diameters ranging from 2 5/8" - 4 3/4". These products feature the simple and fast EZ-Twist adjustment mechanism.

Wire Cup Dispensing Rack

**WR Series Dispensing Organizers**

The overhead wire cup dispensing rack accomodates 6 oz to 44 oz paper, plastic or foam cups with rim diameters ranging from 2 5/8" - 4 3/4". This unique design allows for various angled mounting and overhead positions. This product provides a maximum dispensing solution in a minimum amount of space.

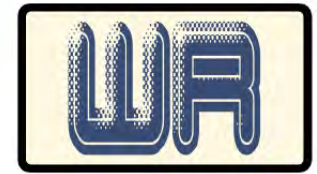

**Overhead Surface Mount Wire Cup Dispensing Rack**

Vendor #	Measurements (W x D x H)	
WR-CT-OVRHD	26 1/4" x 18 1/2" x 6 1/8"	N/S

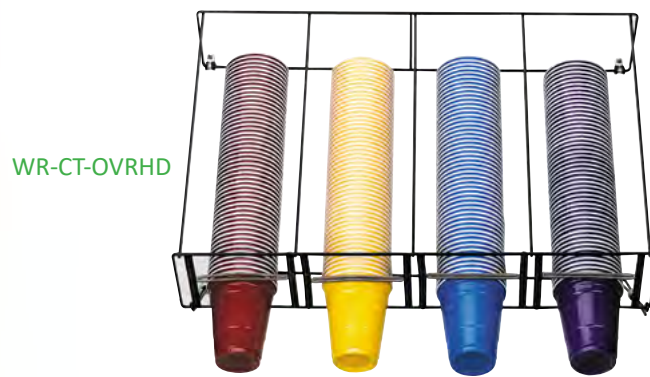

WR-CT-OVRHD

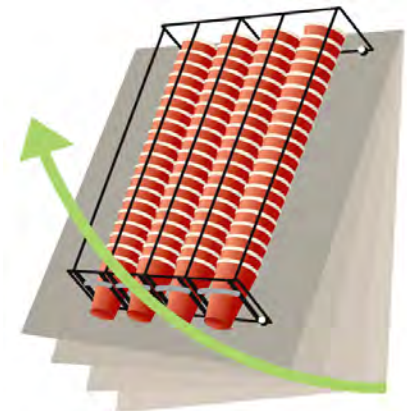

EXAMPLE

**Surface Mount Wire Cup Dispensing Rack**

WR-CC-22 Surface Mount Cup Caddy:

This stainless steel electropolished wire rack stores cups and containers up to 5" in diameter and mounts easily to any flat 22" wide vertical surface. An optional WR-CC-22BKT bracket allows unit to be quickly and easily removed without tools.

Vendor #	Measurements (W x D x H)	
WR-CC-22	22" x 5 1/2" x 19"	N/S

Item #	Description	
WR-CC-22BKT	Optional: Bracket Kit for WR-CC-22	N/S



WR-CC-22

EXAMPLE



WR-CC-22BKT



N/S = Non-Stocked Item, requires special order and lead time.

Lid, Straw, and Condiment Organizers

NLO Series Organizers

Made of durable polystyrene construction that offer an easy way to organize lids, straws or condiments. These units offer maximum organization in a minimum amount of countertop space.



NLO-1B



WLO-1B

Vendor #	Measurements (W x D x H)	Description	
NLO-1B	8" x 20 1/2" x 16 1/2"	Narrow Organizer w/ some removeable dividers	
WLO-1B	15" x 20 1/2" x 16 1/2"	Wide Organizer w/ some removeable dividers	N/S



NLO-WVL



NLO-CTVL



MICRO-1

Vendor #	Measurements (W x D x H)	
NLO-WVL	11 1/2" x 21 3/4" x 20 1/4"	
NLO-CTVL	13 1/2" x 22 1/2" x 20"	
MICRO-1	8" x 11 7/8" x 4 5/8	N/S

N/S = Non-Stocked Item, requires special order and lead time.

# VISI-SLIDE SHELF GLIDES

Visi-Slides are the #1 industry standard glide system for single serve merchandising. It is a gravity-fed system that sits directly on angled shelves in cold vaults, coolers, or ambient shelf applications. All Visi-Slides are available in different channel widths to accommodate the wide range of products in the market.

- Idea for coolers or cold vaults.
- Modular tracks and break offs to fit most shelf sizes.
- Proprietary internal slip agent ensures lasting performance of glide.
- Glide has clear front ring allowing maximum brand exposure.
- Glide is made of virgin polypropylene and is easily recycled.



Only sold by carton.

Slide Item Code	Description	Width	Capacity	Slides per Carton	
VISINVAU	12oz Slim Can or 8oz Energy cans, High Ring	11 Wide	132 Cans / 148 Cans	6	N/S
VISINVPNA	12oz Cans, Low Ring	10 Wide	100 Cans/Bottles	6	N/S
VISINVPNB	16oz Cans, High Ring	10 Wide	100 Cans/Bottles	6	N/S
VISINVPNS	25oz Cans	9 Wide	81 Cans/Bottles	6	N/S
VISINVEAV	1 Liter Bottles	8 Wide	64 Bottles	6	N/S
VISINVPND	32oz / 1 Liter Bottles	7 Wide	49 Bottles	6	N/S
VISINVECU	Extended 36", 12oz Cans	11 Wide	130 Cans	3	N/S
VISINVECT	Extended 36", 20oz Cans	10 Wide	108 Cans/Bottles	3	N/S
VISINVEAT	Extended 36", 30oz / 1 Liter Bottles	10 Wide	100 Cans/Bottles	3	N/S

**IMPORTANT:** Shelf Glides are non-stocked products: *There is a \$15 Drop Ship Charge per Location.*



VISINVEAV

 COLOR: White

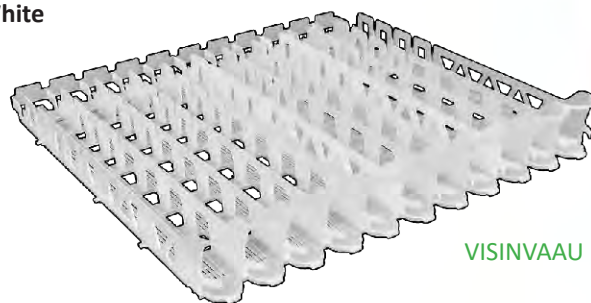

VISINVAU

Visi-Slide Shelf Glides are gravity-fed dispense systems for use with cans or bottles.

N/S = Non-Stocked Item, requires special order and lead time.



# COLD VAULT ADD-A-SHELF

Cold Vault Add-A-Shelf is for use with Cold Vault Rack Systems to support the Visi-Slide Shelf Glides (sold separately).

- Supports Visi-Slide Beverage Glides.
- Includes (4) S-hooks for cold vault uprights.
- Steel Construction - Durable Black Coated Finish.

 COLOR: Black

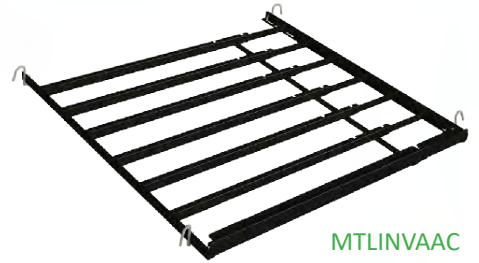

Only sold by carton.

Shelf Item Code	Description	Shelves per Carton	
<b>MTLINVAAC</b>	Add-A-Shelf, Standard Depth	4	N/S
<b>MTLINVAAD</b>	Add-A-Shelf, Expanded Depth	3	N/S

**IMPORTANT:** Shelf Glides are non-stocked products: *There is a \$15 Drop Ship Charge per Location.*

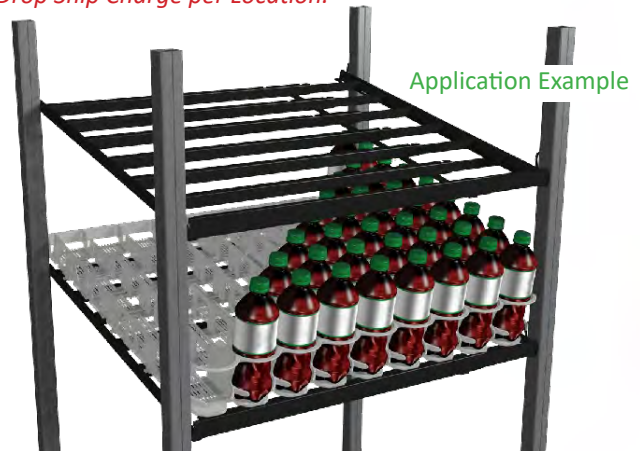
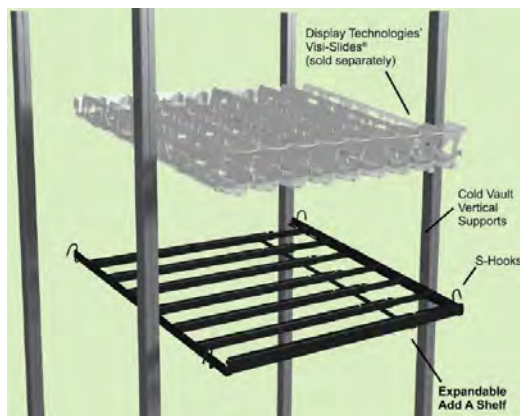

# VISI-FAST PUSHER GLIDES

- Idea for coolers or gondola shelving (Designed for use on flat shelves).
- Always full front faced product with intergrated pusher.
- Maximum brand exposure with clear front lens.
- Maximum product stability and no tipping with high side walls.
- Break-offs with re-positional back panel for additional depths.
- Works with 16", 18", 20" and 22" shelf depths.



Only sold by carton.

Pusher Item Code	Description	Width	Capacity	Slides per Carton	
<b>VISINVEDY</b>	12oz Slim Can / 22" Depth	11 Wide		6	N/S
<b>VISINVENM</b>	12-16oz Cans / 22" Depth	10 Wide	132 Cans/Bottles	6	N/S
<b>VISINVFAD</b>	20oz Cans / 22" Depth	8 Wide	81 Cans/Bottles	6	N/S
<b>VISINVFAE</b>	32oz/1-Liter / 22" Depth	6 Wide	(72) 32oz Bottles / (84) 1-Liter Bottles	6	N/S

**IMPORTANT:** Shelf Glides are non-stocked products: *There is a \$15 Drop Ship Charge per Location.*

**Camtainers - Insulated Beverage Servers  
For hot and cold beverages**

<b>Part # 100LCD</b>	<b>Part # 250LCD</b>	<b>Part # 500LCD</b>	<b>Part # 1000LCD</b>
1 1/2 gallon capacity	2 1/2 gallon capacity	4 3/4 gallon capacity	11 3/4 gallon capacity
Serves (27) 7 oz. cups	Serves (45) 7 oz. cups	Serves (86) 7 oz. cups	Serves (214) 7 oz. cups
10 3/8" W x 11 1/2 D x 17 1/4" H	9" W x 16 1/2 D x 18 3/8" H	9" W x 16 1/2 D x 24 1/4" H	16 1/4" W x 20 3/4" D x 24 1/4" H
			
N/S	N/S		

- **Stackable**
- **Easy Serve Dispenser**
- **Spill proof rim and molded-in handles**
- **No assembly required**

- Attractive design is perfect for front-of-the-house hot and cold beverage service.
- Single-molded, seamless, double-wall, high-density, polyethylene construction is highly durable, dishwasher safe and resists dings and dents. Textured exterior is scratch resistant.
- Polyurethane foam insulation provides excellent hot or cold temperature retention for hours.
- Molded-in handles offer comfortable easy transporting.
- Recessed plastic latches will not rust or corrode and are protected from being hit or damaged.
- Drip proof recessed spigot allows for convenient access. Optional 'Easy Serve Dispenser Lever' offers easy and even beverage dispensing.
- Raised edge, spill proof rim prevents spills and leaks during transport.
- Vent cap on all models helps equalize pressure and release steam.
- Self-adhesive beverage labels included for quick identification of contents.



**Available in 10 colors**

*Most colors are non-stocked items. Ask a sales person to provide availability and pricing.*

**Riser**

Item #	Description	
<b>R500LCD</b>	Riser for use w/ 250LCD and 500LCD	N/S
<b>R1000LCD</b>	Riser for use w/ 1000LCD	N/S



R500LCD



R1000LCD

**Condiment Holder**

Item #	Description	
<b>LCDCH</b>	for use w/ 250LCD and 500LCD	N/S
<b>LCDCH10</b>	for use w/ 1000LCD	N/S



LCDCH



LCDCH10

**Camserver - Insulated Beverage Dispenser**  
For hot and cold beverages

*A contemporary, convenient beverage server for the office or banquet, the Camserver protects piping hot or chilled drinks for hours. Coffee, tea, and ice-cold lemonade can be served side by side with confidence, secured by a double wall shell and thick foam insulation. A top-fill opening design offers fast replenishment without having to remove the cover, while remaining incredibly easy to clean and store. Safe for commercial dishwashers, this Camserver joins classic Cambro durability with the aesthetic of fine dining. Choose from three and five gallon options for versatility in your beverage service, on any occasion.*

- For hot or cold beverages.
- Doublewall shell with thick foam insulation.
- Wide latches are easy to open and close.
- Convenient top-fill opening.
- Drip-free recessed faucet has continuous and individual dispensing.
- 2 product variations (3 or 5 gallon versions).
- 3 neutral color options (Black, Coffee Beige, or Gray).



<b>Part # CSR3110</b>
<b>GIS ITEM # CSR3</b>
CAMSERVER 3-Gallon, Black
Capacity: 3 gallons
13-1/4" W x 18-1/4 D x 23-1/2" H

N/S

<b>Part # CSR5110</b>
<b>GIS ITEM # CSR5</b>
CAMSERVER 5-Gallon, Black
Capacity: 5 gallons
13-1/4" W x 18-1/4 D x 28" H

N/S

N/S = Non-Stocked Item, requires special order and lead time.

 **COLOR: Black (110)**

Portable Beverage Bars

**BAR730**

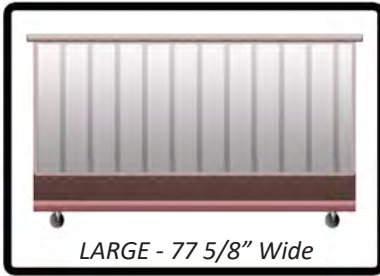

LARGE - 77 5/8" Wide

**BAR650**

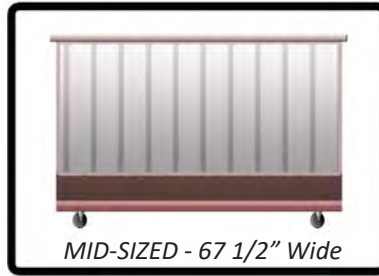

MID-SIZED - 67 1/2" Wide

**BAR540**



SMALL - 54" Wide

**Complete System**

- Completely factory equipped for Post or Pre-Mix soda service.
- Available with Standard or Designer Decor models.

**Basic System**

- Partially equipped for Post or Pre-Mix Soda Service.
- Operator completes installation.
- Available with Standard or Designer Decor models.

**Economy System**

- For bottle, can, or mixer service only.
- Includes ice bin and speed rail.
- Available with Standard or Designer Decor models.
- Available in all three sizes.

**Models**

POST-MIX (Bag-in-Box)

- BAR730PM
- BAR730DSPM
- BAR730PMT
- BAR730DSPMT
- BAR730PMT220
- BAR730DSPMT2

- BAR650PM
- BAR650DSPM
- BAR650PMT
- BAR650DSPMT
- BAR650PMT220
- BAR650DSPMT2

PRE-MIX (Canisters)

- BAR730DX
- BAR730DSDX
- BAR650DX
- BAR650DSDX

**Models**

- BAR730CP
- BAR730DSCP
- BAR650CP
- BAR650DSCP

**Models**

- BAR730
- BAR730DS
- BAR650
- BAR650DS
- BAR540
- BAR540DS



Vinyl Cover Included

**Measurements (W x D x H)**

**BAR730 Models**

Standard Decor: 72 3/4" x 26" x 48"

Standard Decor:

Designer Decor: 77 5/8" x 28" x 47 1/2"

Designer Decor:

**BAR650 Models**

67 1/2" x 28 1/2" x 47 1/2"

**BAR540 Models**

54" x 25 7/8" x 46 1/8"

Portable Beverage Bar Options:

- 1) Select from Three Model Sizes
- 2) Select from Three System Types
- 3) Select from Five Styles

Portable Bars are non-stocked items. Ask a sales person to provide availability and pricing.

Portable Beverage Bars

Five Styles:

# Designer Decor Options For BAR730 and BAR650 models



Standard

 <b>110</b> Black	 <b>191</b> Granite Gray	 <b>194</b> Granite Sand
 <b>421</b> Granite Green w/ Black Base	 <b>420</b> Granite Gray w/ Black Base	
 <b>189</b> Two-Tone Brown Mahogany		



**770 - Chicago**

Black base, coal countertop and smooth brushed pewter panels



**667 - Manhattan**

Black base, coal countertop and brushed pewter panels



**669 - Carmel**

Black base, coal countertop and dark burlwood panels



**668 - Sedona**

Granite sand base, cocoa countertop and light burlwood panels



## Color Options



Standard

Portable Bars are non-stocked items. Ask a sales person to provide availability and pricing.

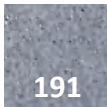
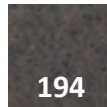
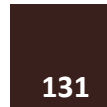
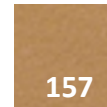
## For BAR540 model

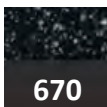
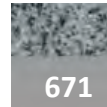
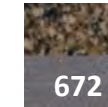
 <b>110</b> Black	 <b>191</b> Granite Gray	 <b>194</b> Granite Sand	 <b>131</b> Dark Brown	 <b>157</b> Coffee Beige	 <b>401</b> Slate Blue	 <b>180</b> Gray
 <b>670</b> Coal Counter w/ Black Base	 <b>671</b> Slate Gray Counter w/ Granite Gray Base	 <b>672</b> Cocoa Counter w/ Granite Sand Base				



## Portable Beverage Bars

### Complete System - Post-Mix (Bag-in-Box)

Standard Decor Models:	BAR730PM	BAR730PMT	BAR730PMT220	BAR650PM	BAR650PMT	BAR650PMT220
Designer Decor Models:	BAR730DSPM	BAR730DSPMT	BAR730DSPMT2	BAR650DSPM	BAR650DSPMT	BAR650DSPMT2
Voltage:	110V	110V	220V	110V	110V	220V
# BIB Syrup Pumps	6	6	6	3	3	3
# BIB Racks (each rack holds 3):	2	2	2	1	1	1
Carbonator:	YES	YES	YES	YES	YES	YES
CO2 Regulator:	YES	YES	YES	YES	YES	YES
CO2 Clamp & Chain:	YES	YES	YES	YES	YES	YES
Ice Sink - 8 Circuit Cold Plate:	YES	YES	YES	YES	YES	YES
Ice Sink and Cover:	YES	YES	YES	YES	YES	YES
Retainer Strap:	2	2	2	1	1	1
Soda Gun (5, 6, or 8 buttons):	8	8	8	5	5	5
Speed Rail (5 or 7 bottle):	7	7	7	7	7	7
Water Pump:	NO	YES	YES	NO	YES	YES
Water Tank:	NO	YES	YES	NO	YES	YES
Water Line Hook Up (city source):	YES	NO	NO	YES	NO	NO
Waste Water Bin:	YES	YES	YES	YES	YES	YES
	N/S	N/S	N/S	N/S	N/S	N/S

### Complete System - Pre-Mix (Canisters)

Standard Decor Models:	BAR730DX	BAR650DX
Designer Decor Models:	BAR730DSDX	BAR650DSDX

CO2 Regulator:	YES	YES
CO2 Clamp & Chain:	YES	YES
Ice Sink - 8 Circuit Cold Plate:	YES	YES
Ice Sink and Cover:	YES	YES
Retainer Strap:	2	1
Soda Gun (5, 6, or 8 buttons):	6	5
Speed Rail (5 or 7 bottle):	7	7
Waste Water Bin:	YES	YES
	N/S	N/S

### Economy System

Standard Decor Models:	BAR540
Designer Decor Models:	BAR540DS

Ice Sink and Cover:	YES
Speed Rail (5 or 7 bottle):	5
	N/S

### Basic System

Standard Decor Models:	BAR730CP	BAR650CP
Designer Decor Models:	BAR730DSCP	BAR650DSCP

CO2 Clamp & Chain:	YES	YES
Ice Sink - 8 Circuit Cold Plate:	YES	YES
Ice Sink and Cover:	YES	YES
Retainer Strap:	2	1
Speed Rail (5 or 7 bottle):	7	7
Waste Water Bin:	YES	YES
	N/S	N/S

### Economy System

Standard Decor Models:	BAR730	BAR650
Designer Decor Models:	BAR730DS	BAR650DS

Ice Sink and Cover:	YES	YES
Retainer Strap:	2	1
Speed Rail (5 or 7 bottle):	7	7
Waste Water Bin:	YES	YES
	N/S	N/S



800-322-4853

Portable Bars are non-stocked items. Ask a sales person to provide availability and pricing.



# Gulf Ice Systems **Has a Parts Department**



**with a warehouse full of parts and accessories**



**In business since 1985**

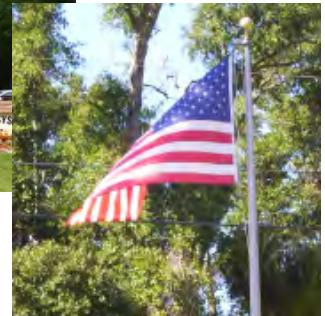

*As of 2019, Gulf Ice Systems has expanded to 40,000 sq ft to meet the growth demands of our customers.*

### *Mission Statement*

Gulf Ice Systems will make every effort to satisfy our customers well beyond their expectations.

This means we will work in conjunction with our partners to support our customers with their strategic route to market.

We will anticipate, grow and respond to our customer's needs, requirements and expectations.





**Gulf Ice Systems**

www.gulficesystems.com

# C-Store Ice & Beverage Dispensing **Solutions**



**NEW Stores**

**OR**



**EXISTING Stores**

● Premier distributor for Cornelius & Ice-O-Matic ●

In business since 1985

## Solutions that improve **DISPENSE PROFIT!**



7790 Sears Blvd.  
Pensacola, FL 32514  
Fax 850-477-2458

**1-800-322-4853**

Point of Contact:  
**Stephen Gallman (x105)**  
[sgallman@gulficesystems.com](mailto:sgallman@gulficesystems.com)







**Gulf Ice Systems**

www.gulficesystems.com

# C-Store Ice & Beverage Dispensing **Solutions**



- We are a premier distributor for Cornelius & Ice-O-Matic.
- We offer dispensing equipment solutions that improve your DISPENSE PROFIT!
- We provide contract pricing upfront.
- We supply, install, service and train. It is a complete solution from one source.
- We are No.1 in the country for Ice Nugget Dispensing solutions!
- We offer complete Turn-Key Solutions!



## Ice and Beverage Dispensing



## Cold and Frozen Beverage Dispensing

7790 Sears Blvd.  
Pensacola, FL 32514  
Fax 850-477-2458  
**1-800-322-4853**

Point of Contact:  
**Stephen Gallman (x105)**  
[sgallman@gulficesystems.com](mailto:sgallman@gulficesystems.com)





# Gulf Ice Systems



Ice-O-Matic

DISPENSE-RITE

TAPRITE

BUNN

EVERPURE

FLOJET

SHURflo

Wander-Bar

Willy

PROCON



## Complete backroom solutions and supporting systems

● Customized and Configured to meet your needs ●



## Installation, Service, and Training



## Decreased lead times as we warehouse locally

7790 Sears Blvd.  
Pensacola, FL 32514  
Fax 850-477-2458

# 1-800-322-4853

Point of Contact:  
**Stephen Gallman (x105)**  
[sgallman@gulficesystems.com](mailto:sgallman@gulficesystems.com)





# Gulf Ice Systems

7790 SEARS BLVD  
 PENSACOLA, FL 32514  
 H: (850) 474-1784  
 FX: (850) 477-2458  
 (800) 322-4853

## REQUEST FOR QUOTE

WWW.GULFICESYSTEMS.COM  
 sales@gulficesystems.com

**THIS IS NOT AN ORDER**



Please print to write or complete interactively. You can either fax your information to (850) 477-2458 or electronically email to sales@gulficesystems.com

Name of Company, Agency, or Individual			
Bill to Address			
Ship to Address			
Name of Contact or Requestor		Contact Phone #	
Contact Fax #		Contact email Address	
Other Contact Info (if applicable)			

Please fill out the contact information above as complete as possible.

Please list the equipment, part(s), and/or product(s) for quote

	Model or Product #	Quantity	Description (or Describe as best as possible)	OFFICE USE
1				
2				
3				
4				
5				
6				
7				

Questions, comments and/or further details regarding your request

To fill out form fields interactively, open in Adobe Reader.

PROVIDING ICE AND BEVERAGE DISPENSING SOLUTIONS 1985

#	Page(s)
100LCD Camtainer	141
100LCD Camtainer	141
1522 Ice Tainer Leg Assemblies	24-27
1522IT Ice Tainers	23
2123 Ice Tainer Leg Assemblies	24-27
2123IT Ice Tainers	23
250LCD Camtainer	141
2-Flavor Tower (Juice or Tea) Beverage Dispenser7	4
2JT Flushing-Sanitizing 10" Cartridge8	6
37X Series Frozen Beverage Dispensers	70
3000 Series Primary CO2 Regulator1	17
4JT Flushing-Sanitizing 16" Cartridge8	6
5000 Series Primary CO2 Regulator1	17
5000 Series Secondary CO2 Regulators	120
500LCD Camtainer	141
77X Series Frozen Beverage Dispensers	67, 71

A	Page(s)
Accessories for CO2 Regulators	121-122
Accessories for Flojet BIB Pumps1	10
Adaptor Charts for Ice Machine Application	12, 14, 32-33, 37
Add-A-Shelf, Cold Vault, for Visi-Slide	140
ADJ Jumbo Cup Dispenser1	28
ADJ Series Cup Dispensers	128
ADJ Slim-Line Cup Dispenser1	28
ADJ-NS Adjustable Cup Dispensers	132
ADJ-NW Adjustable Cup Dispensers	132
AFK Magnetic Air Filters, Elevation Series2	0
Air Pumping Stations for BIB Systems9	8
Axiom Coffee Decanter Brewer	79
Axiom-15-3 Coffee Decanter Brewer7	9



B	Page(s)
B Series Ice Storage Bins	11
Backflow Preventer	116
Bar Guns, Energy Drink	85
Bar Guns, Juice	85
Bar Guns, Flow Control, Post-Mix, Black	82
Bar Guns, Mechanical Control, Post-Mix, Black	83
Bar Guns, No Manifold, Post-Mix, Black	84
Bar Guns, Pre-Mix	85
BAR540 Small Portable Bars	143-145
BAR650 Medium Portable Bars	143-145
BAR730 Large Portable Bars	143-145
Beverage System Fittings	113-116
Beverage System Water Filtration Systems	46-54
Beverage Tubing and Hose, Tools and Accessories	125
Beverage Tubing and Hoses	123-124
Beverage Valves	87-89
Beverage Valves, Touchless	89
Bev-Flex Series 172 Poly-Reinforced Hose	124
Bevlex Series 170 Poly-Reinforced Hose	124
Bevlex Series 200 Clear PVC Tubing	123
Bev-Seal Ultra 974 Cabled Barrier Bundle Tubes	123
Bev-Seal Ultra Series 175 Barrier Hose	124
Bev-Seal Ultra Series 235 Dual Barrier Tubing	124
BFL Jumbo Cup Dispenser	130
BFL Series Cup Dispensers	130
BFL Series Cup Dispensing Cabinets	131
BIB Air Pumping Stations	98
BIB Connectors	102
BIB Flex Rack System, 44239-POWDER	93
BIB Pre-Built and Custom Built Rack Systems	94-97
BIB Shelves	90-92
BIB Syrup Pump Accessories	110
BIB Syrup Pump Fittings	111-112
BIB Syrup Pump Kits	104
BIB Syrup Pumps, T5000 Series	105
BIB Syrup Pumps, G55 Series	106
BIB Syrup Pumps, G80 Pulpjet Pump	106
BIB Syrup Pumps, Heavy Duty Advantage Series	107
Big Mac Carbonator	41
Bin Accessories	20
Bin Adaptor Chart for Ice Machine Application	12-13
Bins, Ice Storage	11
Blades, Cutter Replacements	125
Bonnet Assembly for CO2 Regulators	122
Bracket, Transfer Valve	110
Bracket, BIB Pump(s)	110
Brackets for Cup Dispenser(s) Surface Mounting	126, 128, 130, 134
Brackets for Mounting Flojet BIB Pumps	110
Brix Pumps	107
Bundle Tubing	123

<b>C</b>	<b>Page(s)</b>
C1522 Drop-In Ice Chests	23
C2123 Drop-In Ice Chests	23
Camtainers	141
Camservers	142
Cappuccino Dispenser	78
Carafes for Tea Brewers	77
Carbonated Beverage Water Filtration Systems	46-50
Carbonator Pump Saver and Wall Mounted Shelf	42
Carbonator Shelf	42
Carbonators	41
Carts for 77X Series FBD Dispensers	70
Carts for Viper Series FCB Dispensers	68
CB Series, Drop-In Beverage Dispensers	21
CD Series, Hotel Ice Dispensers	18
Changeover-Valve and Backflow Preventer	116
Chunklet Ice Machines	8, 19
Chunklet Ice Machines, IMD Series	19
Chunklet Ice Machines, WCC Models	8
CIM Models, Ice Machines	2-4
Clamps, Stepless Ear	114
Cleaner, Ice Machine	86
Cleaner, Ice Machine, ScaleKleen	86
Clearbraid Series K3150 Reinforced Hose	124
CO2 Gas Syrup Pumps	105-107
CO2 Management System	118
CO2 Primary Regulators for Soda Systems	117-119
CO2 Regulator Accessories and Parts	121-122
CO2 Secondary Regulators for Soda Systems	120
Coffee Brewer Accessories	81
Coffee Brewer Water Filtration Systems	55
Coffee Decanter Brewers, Axiom Model	79
Coffee Infusion Brewer	80
Coffee or Tea Brewer	79-80
Coffee or Tea Brewer Accessories	77, 81
Coffee Thermal Brewers, Axiom Model	79
Cold Beverage Dispensers	64-65
Cold Coffee Dispenser, NitroPro Mini	78
Cold Plates	42
Cold Vault Add-A-Shelf	140
Coldrink Water Filtration Systems	46-50
Condiment Organizers	138
Conversion Stands for Drop-In Drink Dispensers	22
Countertop Cup-Lid-Straw Stackable System	135
Countertop Ice Water Dispenser, Self-contained	7, 16-17, 19
CSR3110 Camserver	142
CSR5110 Camserver	142
CTC Series Cup Dispensing Cabinets	129
Cubers, Ice Machines	2-4
Cup and Lid Dispensers	126-138
Custom Built BIB Rack Systems	94-97
Cutter, Kuri Snip for 1/2" OD Hose and Tubing	125
Cutters, Beverage Tubing and Hose	125

<b>D</b>	<b>Page(s)</b>
Decanters for Coffee Brewers	81
Deliming, ScaleKleen	86
Digital Refractometer for FCB Machines	109
Drain Tubing, PVC, Series 213 Black	123
Drain Tubing, PVC, Series 215	123
Drain Tubing, Sani-Clean Anti-Microbial Series 218	124
Drop-In Beverage Dispensers, Ice Cooled	21
Drop-In Conversion Stands	22
Drop-In Stands for Ice Cooled Beverage Dispensers	22

<b>E</b>	<b>Page(s)</b>
Economy Water Boosters	98
ED Models, Ice and Beverage Combo Dispensers	28-29
ED Models, Ice Dispensers	17
Elevation Series, Ice Machines, Cube	2-4
Enduro Flavor Blast Retro Fit Kits	31
Enduro Ice Dispensers	17
Enduro Series, Ice and Beverage Combo Dispensers	28
Energy Drink Bar Guns	85
Equipment Cleaners	86

<b>F</b>	<b>Page(s)</b>
Filters for Coffee Brewers	81
Filters for Tea Brewers	77
Fittings for Beverage Systems	113-116
Fittings for SHURflo BIB Pumps	112
Fittings for Taprite Regulators	122
Flake Ice Machines, MFI Models	9
Flavor Blast ED, Ice and Beverage Combo Dispensers	29
Flavor Blast Retro Fit Kits	31
Flavor Fusion Ice and Beverage Combo Dispensers	36
Flavor Overload Ice and Beverage Combo Dispenser	36
Flex BIB Rack System w/ Riser	93
Frozen Beverage System, Ultra NT Slush Machines	72
Frozen Carbonated Beverage (FBD), 37X Series	70
Frozen Carbonated Beverage (FBD), 77X Series	69, 71
Frozen Carbonated Beverage (FBD), Carts	70
Frozen Carbonated Beverage (FCB), Carts	68
Frozen Carbonated Beverage (FCB), Viper Series	67

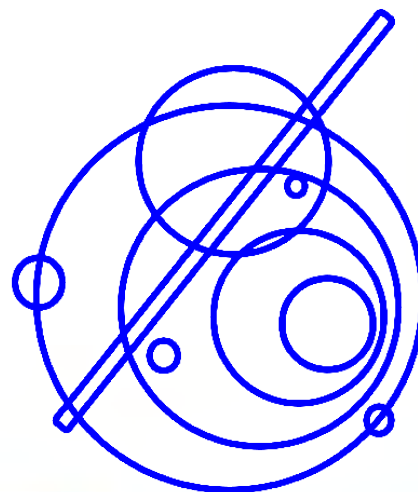

<b>G</b>	<i>Page(s)</i>
G55 Series BIB Syrup Pumps	106
G56 Series BIB Beer Pumps1	06
G80 Series BIB Plupjet Pumps	106
GEM Models, Pearl Ice Machines	6-7
GEMD270A2 Ice Water Dispenser7	
GEMU090 Undercounter Ice Machine7	
Glides, Shelf, for Cans and Bottles	139-140
Gourmet Ice Beverage, Ultra NT	72
Grill Guard Kits for Remote Condensers	10
Guage Guard for CO2 Regulators	118

<b>H</b>	<i>Page(s)</i>
Hose, Beverage	123-124
Hotel Ice Dispensers, CD Series1	8

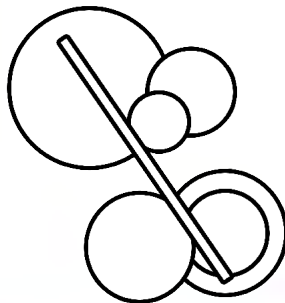
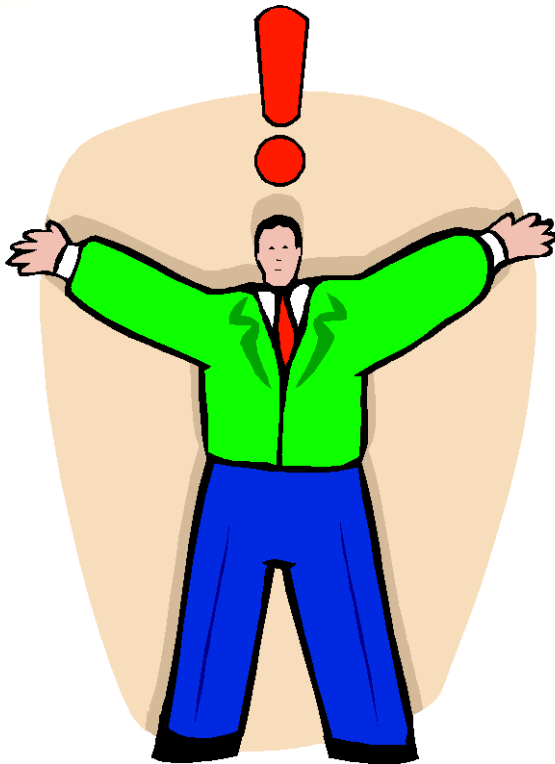

<b>I</b>	<i>Page(s)</i>
ICB-DV Tall Infusion Coffee Brewer	80
Ice and Beverage Combo Dispensers, Enduro	28
Ice and Beverage Combo Dispensers, Enduro FB	29
Ice and Beverage Combo Dispensers, FF and FO	36
Ice and Beverage Combo Dispensers, IDC	35
Ice and Beverage Combo Stands, Enduro	30
Ice and Water Dispensers, Enduro Models	17
Ice and Water Dispensers, IOD Series	16
Ice Chests	23-27
Ice Cooled Beverage Drop-In Dispensers	21
Ice Cooled Beverage Drop-In Stands	22
Ice Machine Cleaner	86
Ice Machine Magnetic Air Filters	20
Ice Machine Water Filtration Systems	43-45
Ice Machine, Chunklet	8
Ice Machine, CIM Series	2-4
Ice Machine, Cube, Undercounter	5
Ice Machine, ICEU Series	5
Ice Machine, Flake, MFI Series	9
Ice Machine, Pearl, Countertop	7
Ice Machine, Pearl, GEM Series	6-7
Ice Machine, Pearl, Undercounter	7
Ice Machines, Cube, Elevation Series	2-4
Ice Maker Adaptor Chart for Bin Application	12-13
Ice Maker Adaptor Chart for Enduro Application	32-34
Ice Maker Adaptor Chart for FF, FO, IDC Application	37-40
Ice Maker Adaptor Chart for Ice-Drink Application	32-34
Ice Maker Dispensers, Self-Contained, IMD Series	19
Ice Scoops	20
ICE Series, Undercounter Ice Machines	5
Ice Storage Bins	11
Ice Storage Bin Accessories	20
Ice Tainer Leg Assemblies	24-27
Ice Tainers	23-27
Ice Water Dispenser, GEMD270A2	7
Ice-Beverage Combo Dispensers	28-29
Ice-Drink or Ice-Bev Combo Adaptor Charts	32-34
Ice-Water Dispensers	16-17
Ice-Water Dispensers, ED Series	17
Ice-Water Dispensers, IOD Series	16
IDC Pro Fast Gate Ice and Bev Combo Dispenser	35
IDC PRO Ice and Beverage Combo Dispenser	35
IFI4C In-Line Water Filtration System	45
IFI8C In-Line Water Filtration System	45
IMD Chunklet Ice Machine	19
iMix-3S+ Cappuccino Dispenser	78
Installation Kits	100-101, 104
Insurice Series, Water Filtration Systems	43
IOD Series, Ice-Water Dispensers	16
IOMQ Water Filter Replacement Cartridge	44
IOMQ-S Water Filter Replacement Cartridge	44
IOMQ-XL Water Filter Replacement Cartridge	44
ITCB-DV Coffee or Tea Brewer	76

## J Page(s)

John Guest Fittings	115-116
Juice Bar Guns	85
Juice BIB Pumps	106-107
Juice Dispensers	60-63
Juice Dispensers, JDF	63
Juice Dispensers, Quest Elite	60-62
Juice Tower 2-Flavor Dispenser	74

## K Page(s)

KPU090 Sump Pump, for GEMU090	7
Kuri Snip Cutter for 1/2" OD Hose and Tubing	125

## L Page(s)

LCDCH Condiment Holder for Camtainers	141
LCDCH10 Condiment Holder for Camtainers	141
Lid Dispensers	133-135
Line Sets, Precharged Tubing Kits	10

## M Page(s)

M4 Bar Guns	82-85
Magnetic Air Filters, Elevation Series	20
MC2 Water Filtration Systems	46-46, 51
MFI Models, Flake Ice Machine	9
Mounting Panels for BIB Pumps	110

## N Page(s)

Nickel-Safe Ice Machine Cleaner	86
NitroPro Mini Cold Coffee Dispenser	66
NLO Series Organizers	138
Nugget Ice Machines	6-8

## O Page(s)

Oetiker Clamps, Stepless Ear	114
------------------------------	-----

## P Page(s)

Palm Abbe Digital Refractometer	109
Parts for CO2 Regulators	121-122
Pearl Ice Machines, GEM Series	6-7
Pliers, Clamp Pincer for Oetiker Clamps	114, 125
Portable Beverage Bars	143-145
Post-Mix Bar Guns	82-84
Post-Mix Installation Kits	100
Pre-Built BIB Rack Systems	94-97
Precharged Tubing Kits (Line Sets)	10
Pre-Mix Bar Guns	85
Pre-Mix Installation Kit	101
Pressure Guages for CO2 Regulators	121
Primary CO2 Regulators	117-119
Prism Beverage Valve	88
Pump Saver	42
PVC Drain Tubing, Series 213 Black	123
PVC Drain Tubing, Series 215	123
PVC Tubing, Bevex Series 200 Clear	123

## Q Page(s)

Quest Elite 2000 Juice Dispensers	60-62
Quest Elite 4000 Juice Dispensers	60-62

## R Page(s)

R1000LCD Riser for 1000LCD Camtainer	141
R500LCD Riser for 250LCD and 500LCD Camtainer	141
Rack System, BIB w/ Riser, 44239-POWDER	93
Rack Systems, BIB, Pre-Built	94-97
RCA Models, Remote Condensers	10
Refractometer, Digital, Palm Abbe	109
Refrigerant Line Tubing Kits, Precharged	10
Regulator Accessories and Parts	121-122
Regulator Repair Kits, Cornelius	119-120
Regulators, CO2 Primary and Secondary	117-120
Remote Condenser Grill Guard Kits	10
Remote Condensers, RCA and RGA Series	10
Remote Condensers, for WCC Series	8
Replacement Blades for Cutters	125
Replacement Caps for CO2 Regulators	121
RT Precharged Tubing Kit for R404A	10
RGA Models, Remote Condensers	10

## S Page(s)

Sani-Clean Anti-Microbial Series 218 Drain Tubing	124
Sanitizing Cartridges (must add sanitizing agent)	86
Scale Remover, ScaleKleen	86
ScaleKleen Deliming/Scale Remover	86
Scoops, Ice	20
Secondary CO2 Regulators	120
Series 213 Black PVC Drain Tubing	123
Series 215 PVC Drain Tubing	123
Series K3150 Reinforced Hose, Clearbraid	124
Shelf, Carbonator	42
SLR Series Cup Dispensers	127
SLR Series Cup Dispensing Cabinets	127
SLR Series Lid Dispensers	134
SLR Series Straw Dispenser	134
Slush Machine, Frozen Beverage, Ultra NT	72
Small Carb Carbonator	41
Stackable Countertop Cup-Lid-Straw System	135
Stands, Ice and Beverage Combo Dispensers	30
Stepless Ear Clamps	114
STL Series Cup Dispensers	126
STL Series Cup Dispensing Cabinets	126
Sump Pump, High Capacity, for ICEUXXX	5
Sump Pump, KPU090, for GEMU090	7
Syrup Pumps for BIB Systems	104-107

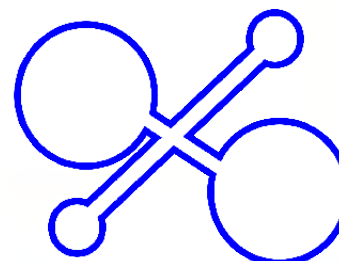

T	Page(s)
T5000 Series BIB Syrup Pumps and Kits	105
TB3Q Single Tea Brewer	75
TB6Q Twin Tea Brewer	75
Tea Brewer Accessories	77
Tea Brewer Water Filtration Systems	55
Tea Brewers	75-76
Tea Brewers, Automatic	75
Tea Dispensers, Multi-Valve	73
Tea Install Kits for BIB Dispensing	101
Tea or Juice Tower, 2-Flavor	74
Tea Pump Kits, BIB Install Kits	101
Tea Tower 2-Flavor Dispenser	74
Touchless Beverage Valves	89
Transfer Valve	110
Transfer Valve Bracket	110
Tubing Kits, Precharged Line Sets	10
Tubing, Beverage	123-124
Tubing, Bundled	123

U	Page(s)
Ultra NT Frozen Beverage System	72
Undercounter, Ice Machines	5

V	Page(s)
VA Balance Control Carbonator	41
Valves, Beverage, Prism	88
Valves, Beverage, Touchless	89
Viper Elite 2 FCB Dispensers	67
Viper Elite 3 FCB Dispensers	67
Viper Elite 4 FCB Dispensers	67
Viper Series, FCB Dispensers	67-68
Visi-Fast Pusher Glides	140
Visi-Slide Shelf Glides	139
Visi-Slide Add-A-Shelf	140
Visual Display Cold Beverage Dispensers	64-65

W	Page(s)
Water Boosters	98-99
Water Filtration Systems	43-59
Water Filtration Systems, Carbonated Beverage	46-50
Water Filtration Systems, Coffee and Tea Brewers	55
Water Filtration Systems, Ice Machines	43-45
Water Filtration Systems, Multiple Applications	51-54
WCC Models, Chunklet Ice Machines	8
Wire Cup Dispensing Racks	136-137
WR Series Wire Cup Racks	136

*Because we stock most items, we can usually ship the same day as receipt of order.*



*(Exceptions do apply that are out of our control, but we do try to deliver orders as fast as possible)*

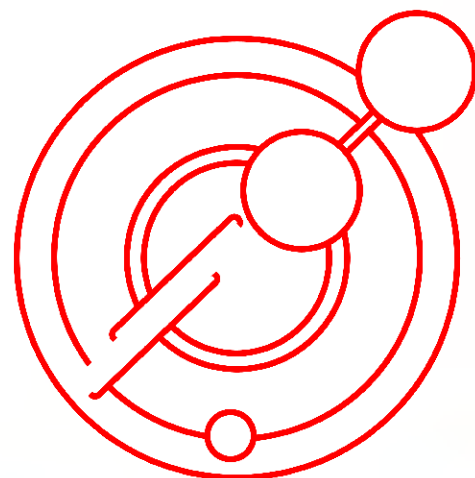



# GULF ICE SYSTEMS





**Gulf Ice  
Systems**

NOTES

**NOTES**

Lined area for taking notes, consisting of multiple horizontal lines.



# Need Service?

**1-800-322-4853 (x114)**

**We have a full service ice & beverage  
equipment service and warranty  
administration departments.**

**We service what we sell and fully back  
all manufacturer's warranty for the  
equipment sold by us.**

(Certain restrictions apply. All warranties required to follow  
manufacturer's warranty allowances and guidelines)

**We also provide complete Ice and Beverage system packages with professional installation.**

*The "2024 +" is a dealer and customer catalog designed to be used for product reference and specifications only.*

*Published in the year 2024, this catalog is to be used for sequential years until requiring a complete update, such as when an entire product line is discontinued. Thus, we call this our 2024 + catalog.*

*DISCLAIMER: To the best of our knowledge, the information presented in this catalog is valid and was researched for accuracy. As such, any misrepresentation of product data may be a result of the source material or came into existence by simple human error and is not intentional.*



Your Partner Providing Ice and Beverage Dispensing Solutions!

[www.gulficesystems.com](http://www.gulficesystems.com)