

PROJECT: _____
 ITEM # _____ QTY: _____
 MODEL # _____
 AIA # _____ SIS # _____

ELEVATION SERIES™ CUBE ICE MAKER

CIM0430HA90



Features and Benefits

- Uses R290 for a more environmentally friendly and efficient refrigerant.
- Modular design and dual exhaust for flexible application and easy installation on bins or dispensers.
- Easy to clean with front facing evaporator and dishwasher safe (up to 180°F) components.
- Easy and quick cleaning reduces operating costs.
- Simple service with many common parts across all CIM machines.
- Harvest Assist provides consistent ice production for the life of the ice maker while reducing energy consumption and increasing capacity.
- Durable, electroless nickel plating on all evaporator plates ensures reliability.
- Constructed from corrosion-resistant and fingerprint-proof aluminum.

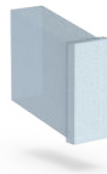

ICE FORMS	
HALF CUBE	3/8 x 7/8 x 7/8 in.
	10 x 22 x 22 mm

BIN CHART									
Model #	B40	B42	B55	B700-30	B110	B1000-48	B1300-48	B1325-60	B1660-60
capacity	344 lbs (156 kg)	351 lbs (160 kg)	510 lbs (232 kg)	680 lbs (308 kg)	854 lbs (388 kg)	1,000 lbs (454 kg)	1,320 lbs (599 kg)	1,325 lbs (601 kg)	1,660 lbs (753 kg)
width	30 in (762 mm)	22 in (559 mm)	30 in (762 mm)	30 in (762 mm)	48 in (1,219 mm)	48 in (1,219 mm)	48 in (1,219 mm)	60 in (1,524 mm)	60 in (1,524 mm)
Kit for combining wider bins with smaller models	Kit Not Required	Not Compatible	Kit Not Required	Kit Not Required	BPF-1	Kit Not Required	Kit Not Required	Kit Not Required	Kit Not Required

See Ice-O-Matic Price List for Adapter Kits to combine ice makers with most available ice/beverage dispensers.



CIM0430HA90 shown atop of bin B55 (sold separately)

Warranty

- Ice Maker: **3 years parts and labor**
- Evaporator and Compressor: **5 years parts**
- Evaporator: **7 Years Parts and Labor** (if enrolled in the filter program)

Options & Accessories

- KSI-1 - Safe Ice Module
- KCUBEDISPB for mounting to a dispenser
- B55

Water Filter

- Manifold System IFQ1 gets replacement filter IOMQ (1)

Line drawing note: Numbers with quote symbol " are in inches. Numbers enclosed in [brackets] are in millimeters.

PLAN / TOP VIEW

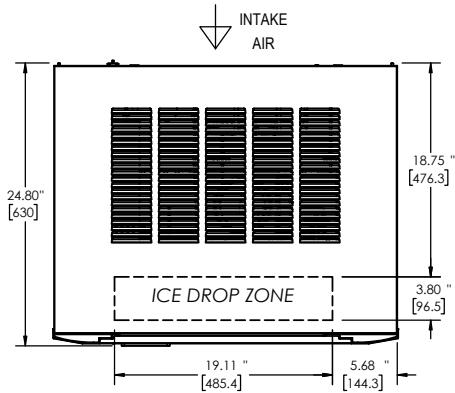

ELEVATION / FRONT VIEW

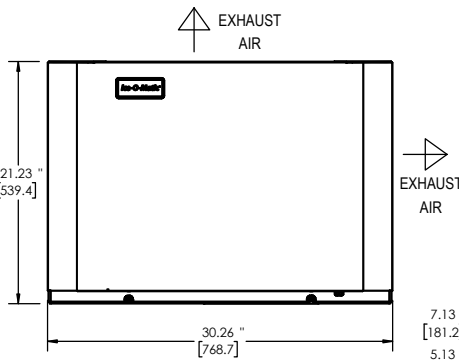

UTILITIES / BACK VIEW

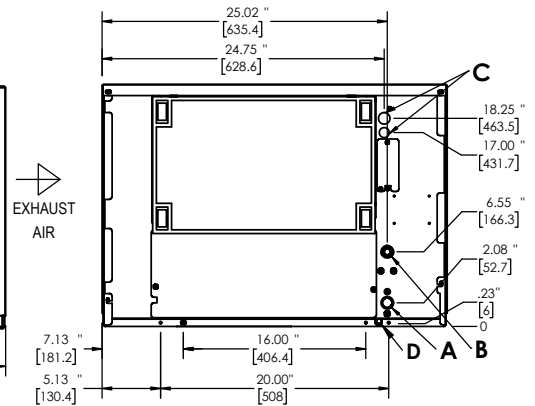

Air Cooled

- A. Ice Maker Drain, 3/4" FPT
- B. Ice Maker Potable Water Inlet, 3/8" FPT
- C. Electrical Connection, Φ .875" [22.2] (2)
- D. Condensate Base Drain, Φ .50" [12.7]

SPECIFICATIONS	
Model	CIM0430HA90
Condensing Type	Air
Voltage/Hertz/Phase	115/60/1
Min. Circuit Amp	11.4 A
Max Breaker Size	15 A
kWH per 100 lbs of ice at 70°F air / 50°F water	3.15
kWH per 100 lbs of ice at 90°F air / 70°F water	4.95
BTU (approx per hour)	5650
Number of Wires	3 (including ground)
Refrigerant	R290A
Refrigeration Charge	140 g
Ice Production per 24 hrs	
70° air / 50° water lbs (kg)	90° air / 70° water lbs (kg)
435 (197)	312 (142)
Water Usage gallons per 100 lbs of ice 90°F air / 70°F water	
Potable	Condenser
17	N/A

OPERATING REQUIREMENTS		
	MINIMUM	MAXIMUM
Ambient Temp. Range Air	50°F (10°C)	100°F (38°C)
Water Temp	40°F (4°C)	100°F (38°C)
Water Pressure	20 PSIG (1.4 BAR)	80 PSIG (5.5 BAR)
DIMENSIONS		
Unit Width	30.25 in.	768.35 mm
Unit Depth	24.25 in.	615.95 mm
Unit Height	21.25 in.	539.75 mm
Shipping Weight	147 lbs / 67 kg	
Shipping Dimensions (in.)	33 (W) x 27 (D) x 27 (H)	
Shipping Dimensions (mm)	838.2 (W) x 685.8 (D) x 685.8 (H)	